

Recent Advancements in Nanoscale IR Spectroscopy and Imaging

Anirban Roy, Qichi Hu, Honghua Yang, Miriam Unger and Curtis Marcott

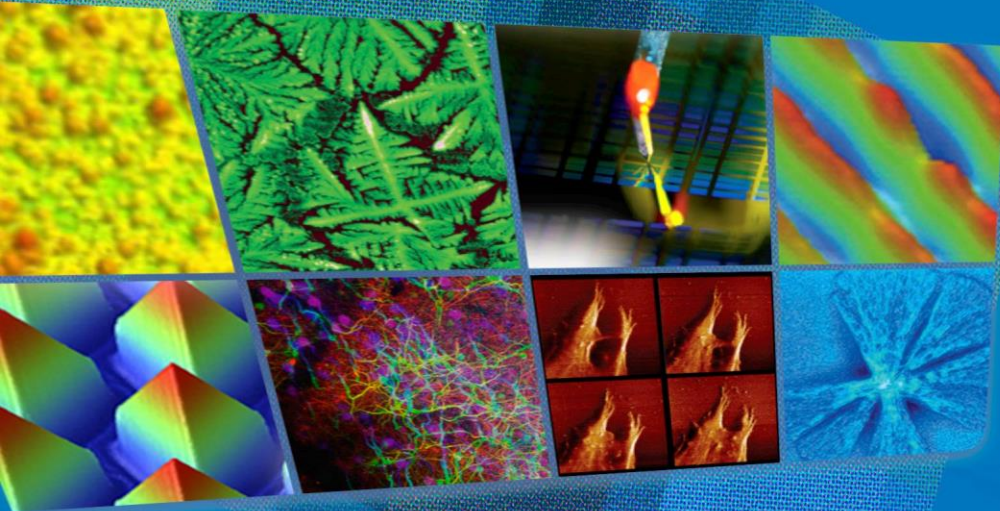

Atomic Force Microscopy
3D Optical Microscopy
Fluorescence Microscopy
Tribology
Stylus Profilometry
Nanoindentation

Outline



- Company Background
- Introduction to AFM-IR
- Latest AFM-IR Advancements
 - Resonance Enhanced AFM-IR
 - HyperSpectral Imaging/Spectroscopy
 - Tapping AFM-IR Imaging/Spectroscopy
 - Technical Overview
 - Applications
- s-SNOM Technology and Applications
- Tunable IR Laser Options
- Summary

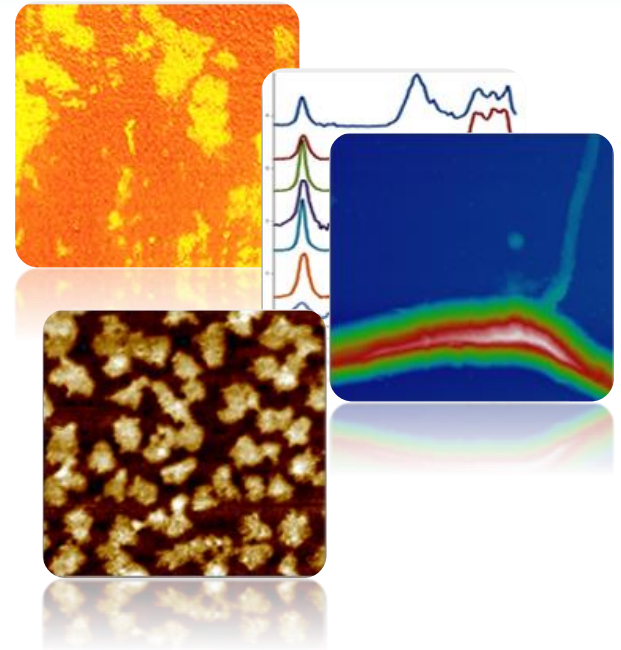



Anasys joins Bruker Nano Surfaces Division

Strengthening the world of nanoanalysis and nanomechanical materials characterization- together



- Bruker Nano Surfaces Division acquired Anasys Instruments Corp on April 10th 2018
- All nanoIR products are now integrated into the Bruker Nano Product Support

Nanoscale IR spectroscopy

2010

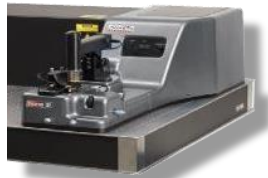

nanoIR™
1st Generation
AFM-IR

2014



nanoIR2™
2nd Generation AFM-IR
Top Down Configuration &
Resonance Enhanced

2015



nanoIR2-s™
Combined
IR s-SNOM & AFM-IR

2016



nanoIR2-FS™
3rd Generation
FASTspectra

2017

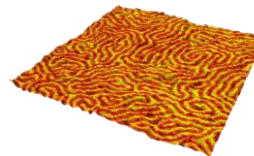

Tapping AFM-IR
HYPERspectra

2018



NEW
nanoIR3™
Latest Generation
nanoIR platform with
Tapping AFM-IR

Infrared Spectroscopy Introduction

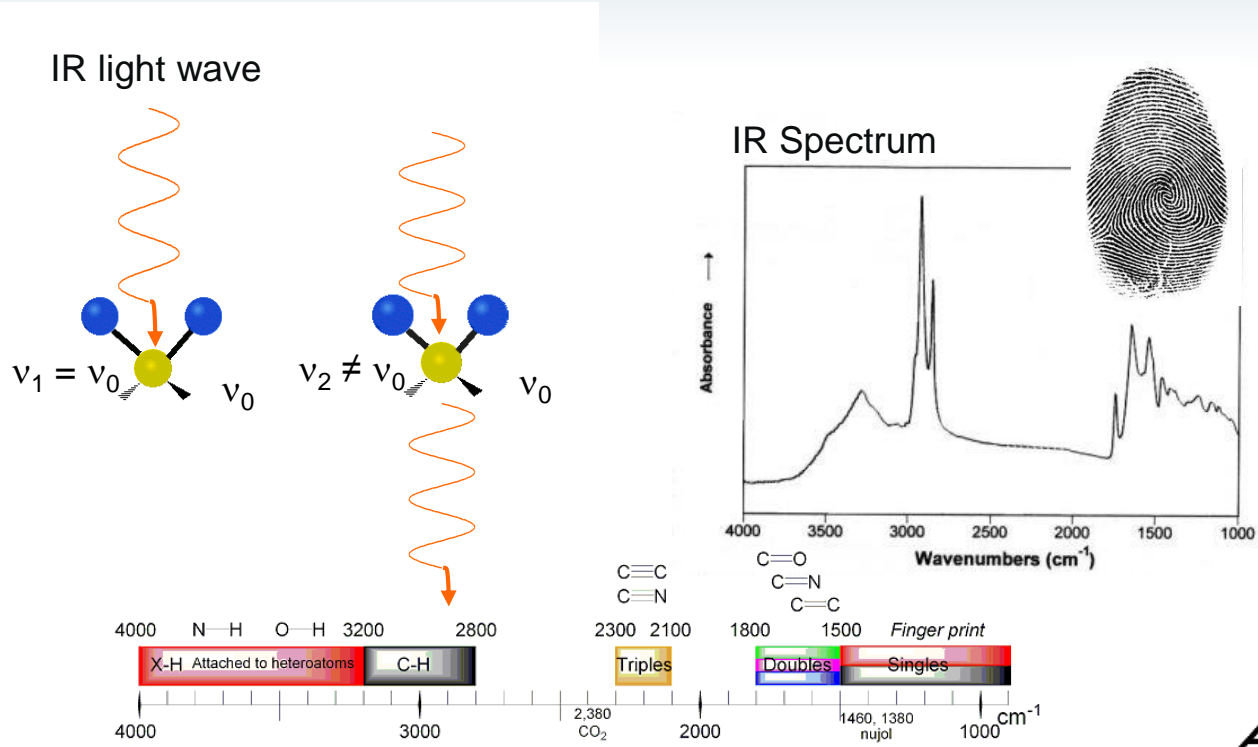

Source: Wikipedia

Power and Limitations of Infrared Microspectroscopy

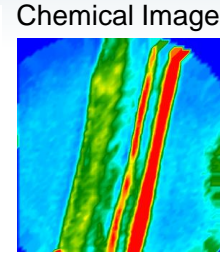
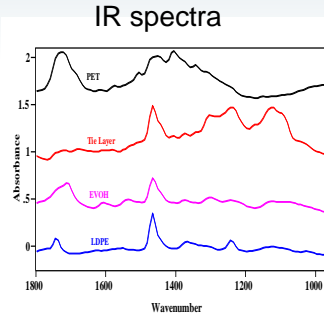
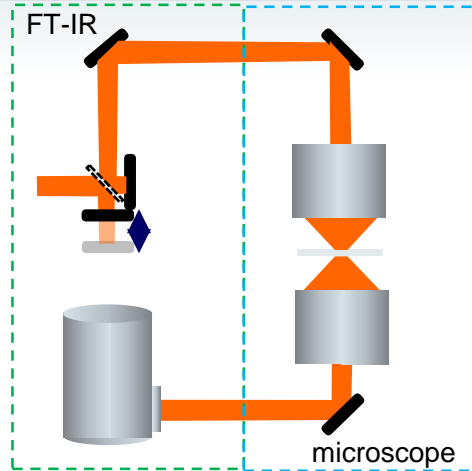

IR microspectroscopy applications

- Materials Science
- Consumer products
- Pharmaceuticals
- Life sciences
- Health & beauty
- Forensics

Multilayer film, courtesy of Dr. Curtis Marcott

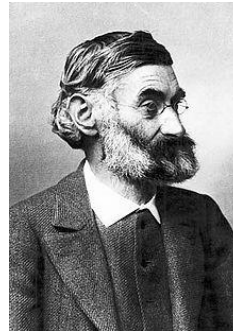
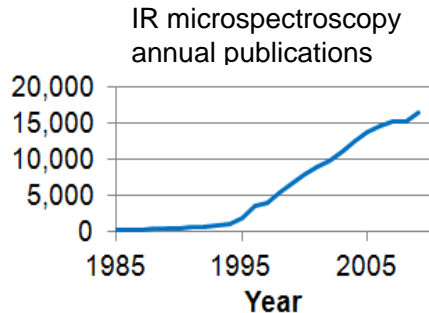

Sampling Method	Diffraction limited resolution*	Practical resolution limit
Transmission	2λ	$\sim 10\text{-}30\ \mu\text{m}$
ATR	0.5λ	$\sim 3\text{-}10\ \mu\text{m}$

Abbe diffraction limit:
Practical resolution many microns

AFM-Based IR Spectroscopy (AFM-IR)

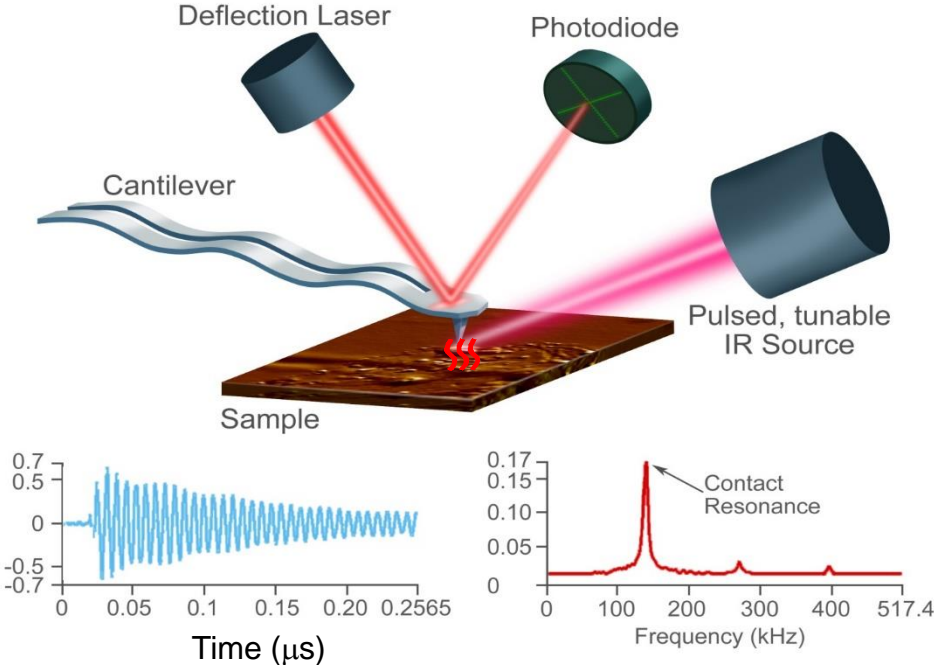

Dazzi, A.; Prazeres, R.; Glotin, F.; Ortega, J.M.; *Opt. Lett.* 2005, 30, 2388-2390.



Alexandre Dazzi
2014 Ernst Abbe Award

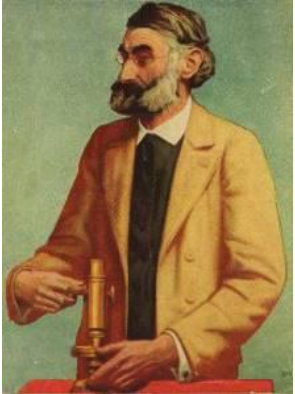

Ernst Abbe

Nanoscale IR Spectroscopy

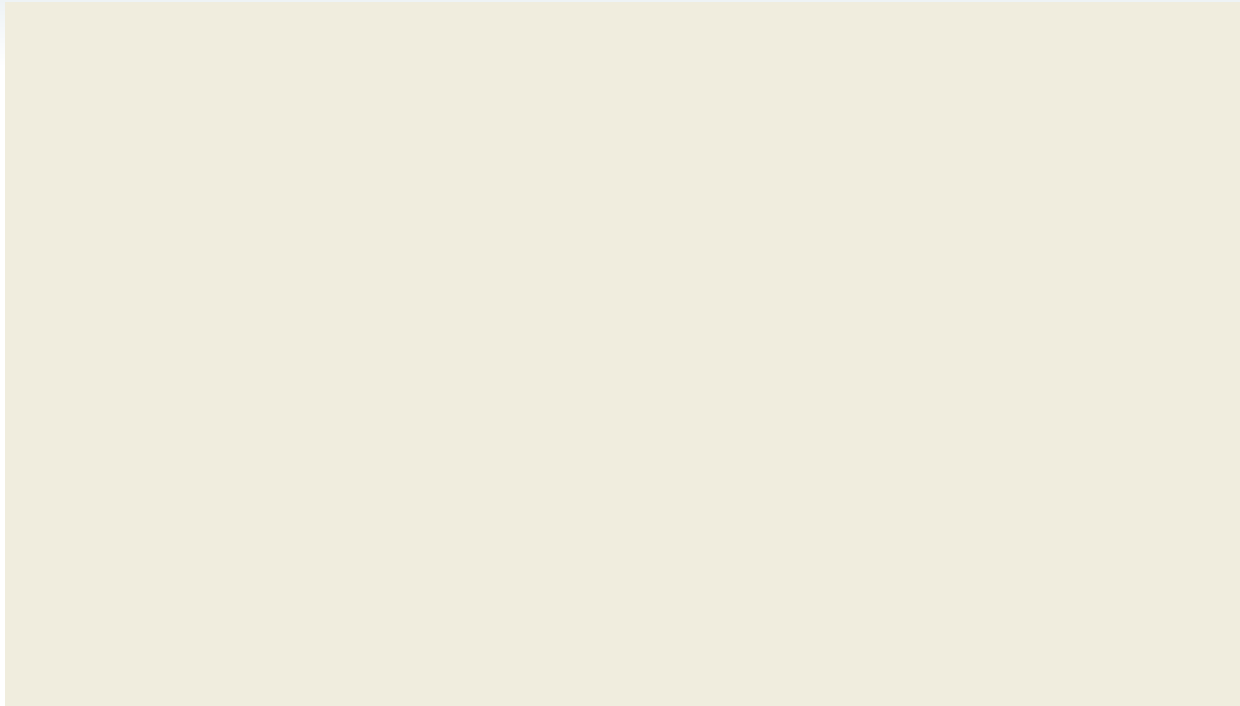

nanoscale infrared imaging & spectroscopy capabilities



Nanoscale IR
chemical analysis

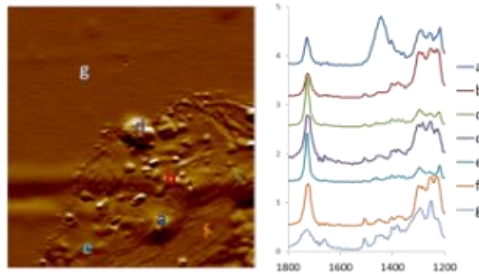

Chemical composition &
nanoscale property mapping

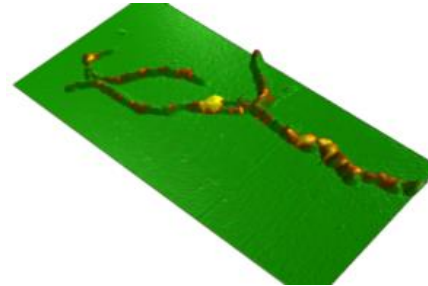

Rich, interpretable
spectra
directly correlates to FTIR

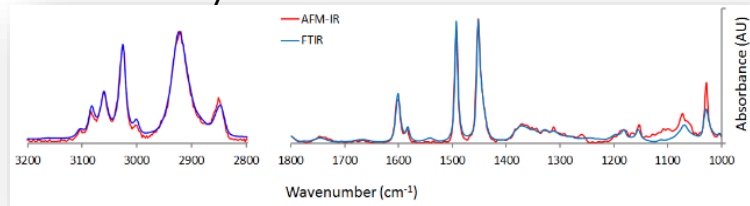

Monolayer sensitivity &
high spatial resolution

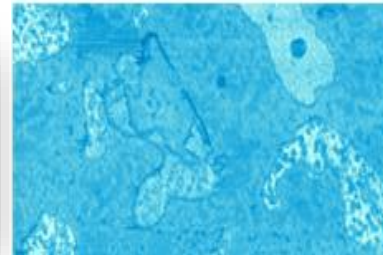

Broad range of nanoIR applications



Polymer blends & Block

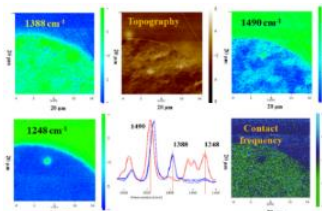

Multilayer films

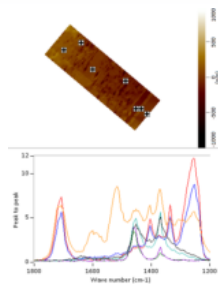

Nanofibers

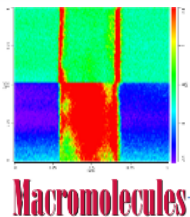

2D Materials/Graphene

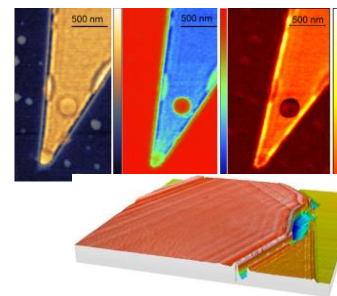

Nano-Composites

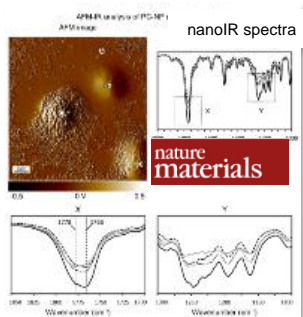

Organic nano Contaminant

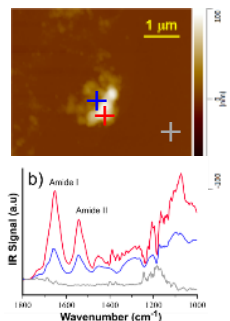

Life Science

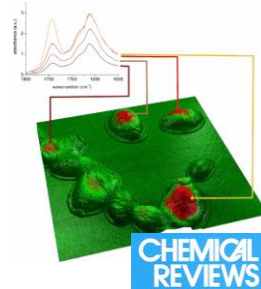

Perovskites & Solar Cells

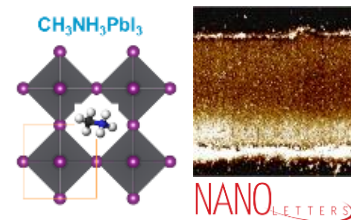

ANASYS
INSTRUMENTS
The nanoscale spectroscopy company

Resonance Enhanced Mode



➤ Demonstrated by Pr. Belkin team in 2011 (Opt. Express)

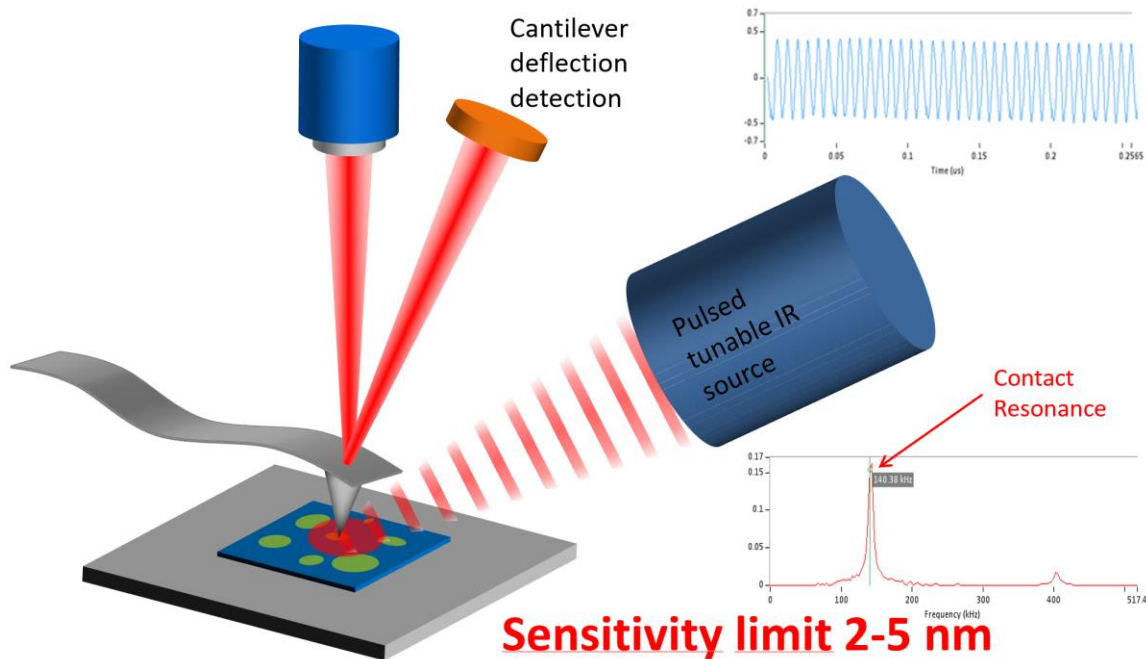

Resonance Enhanced Mode

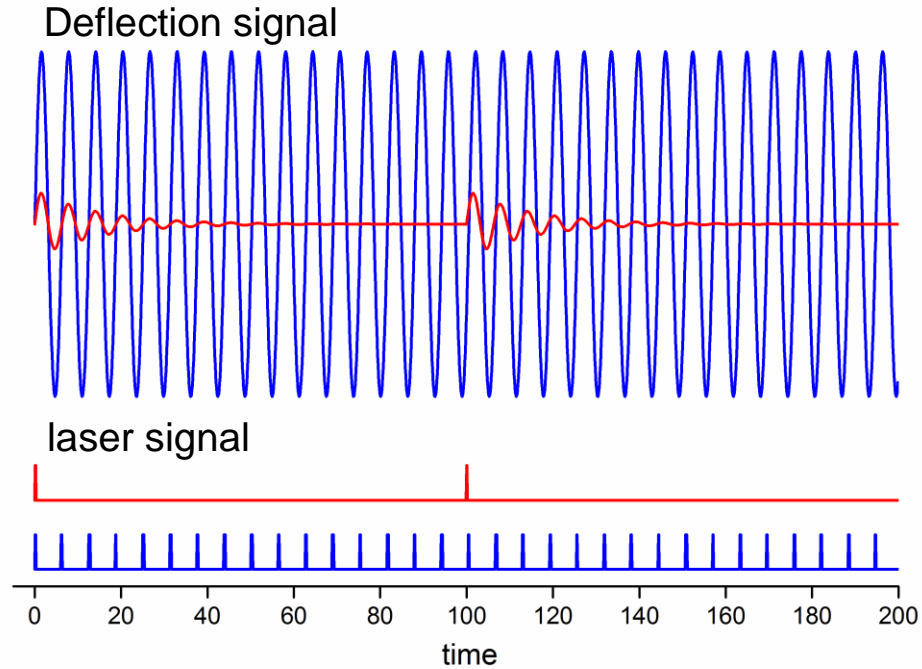

Forced resonance makes AFM-IR more sensitive



Laser repetition rate

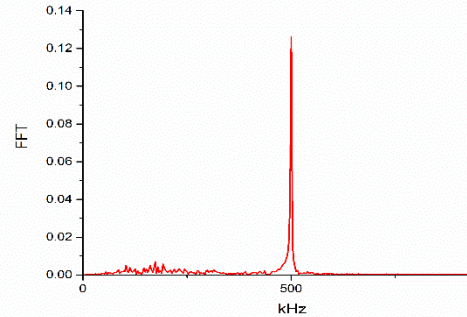
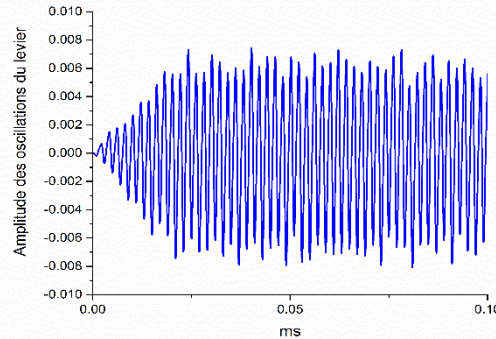
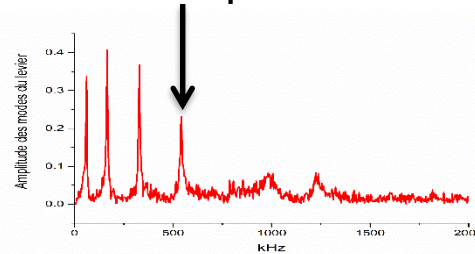

Single Monolayer Sensitivity

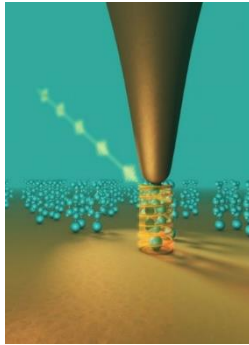

NATURE PHOTONICS DOI: 10.1038/NPHOTON.2013.373

LETTERS

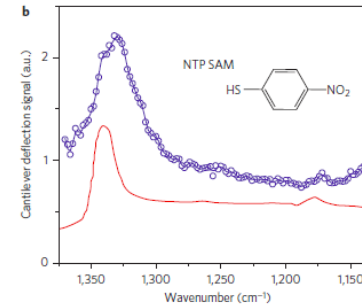
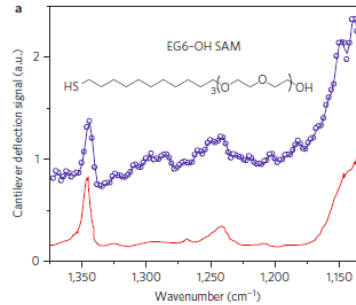

F. Lu, M. Jin, and M.A. Belkin, *Nat. Photonics* **8**, 307–312 (2013).

Resonance enhanced AFM-IR of PEG monolayer

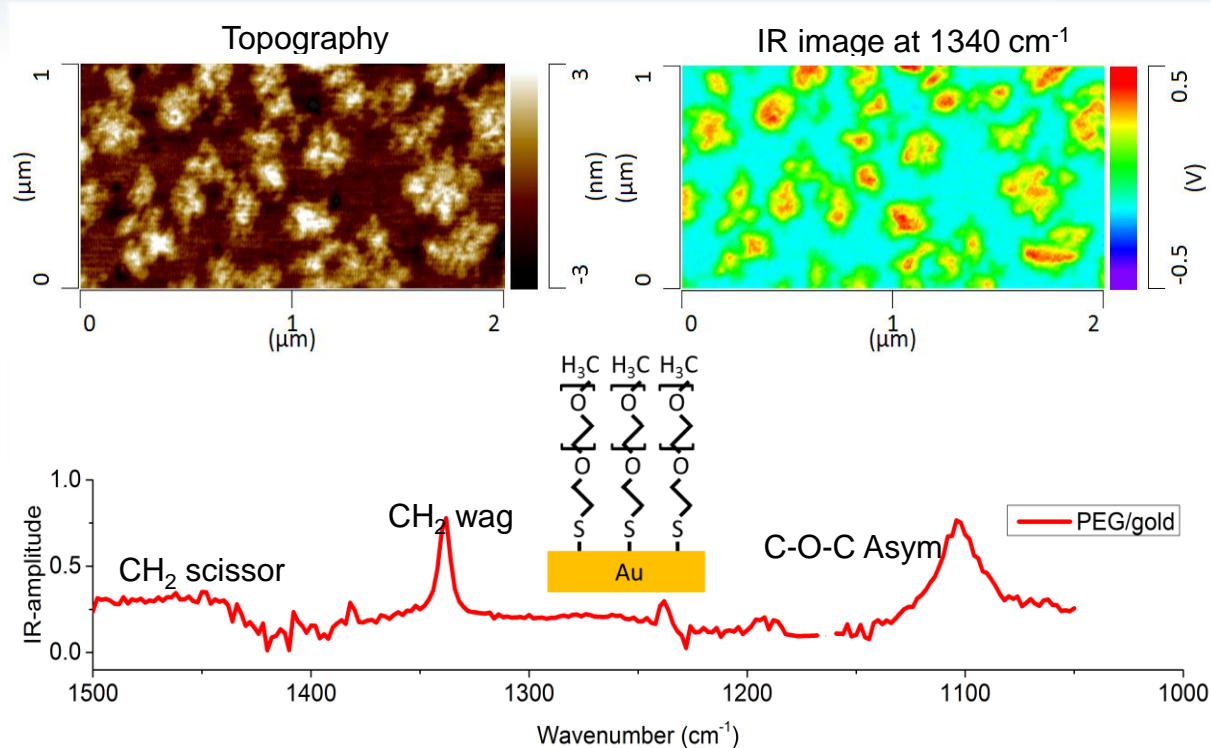

Purple Membrane (Resonance Enhanced AFM-IR)

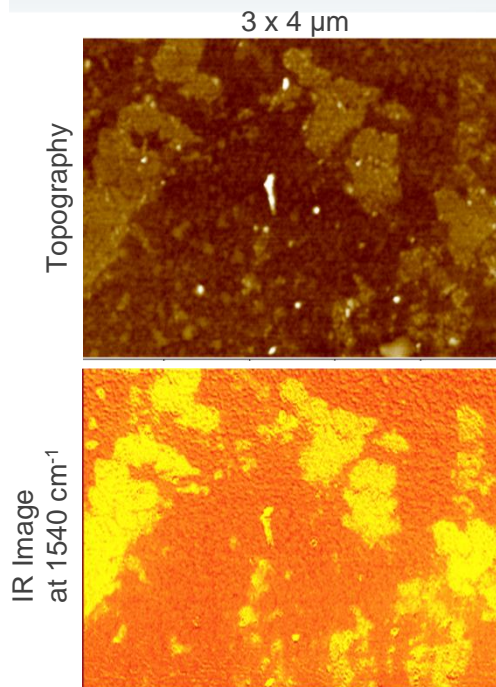
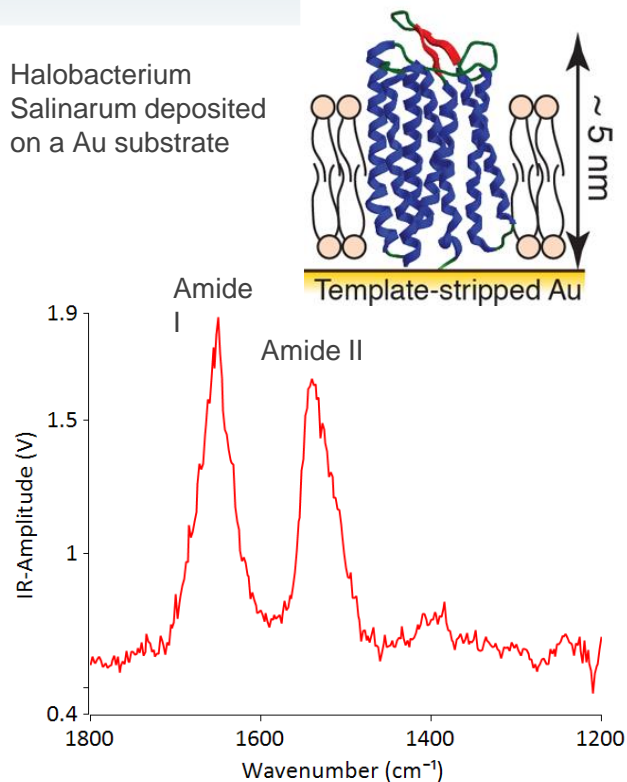

QCLs are getting faster!



Single spectrum, 400 msec sweep, 0.2 msec time constant, no averaging

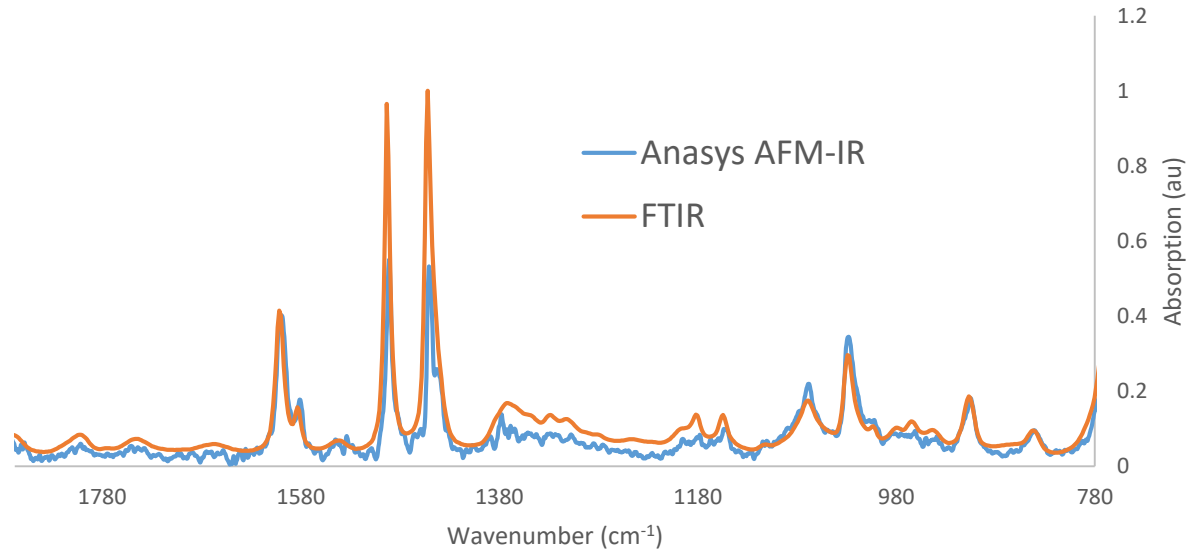

Faster Scanning Enables Hyperspectral Imaging



Hyperspectral image cube

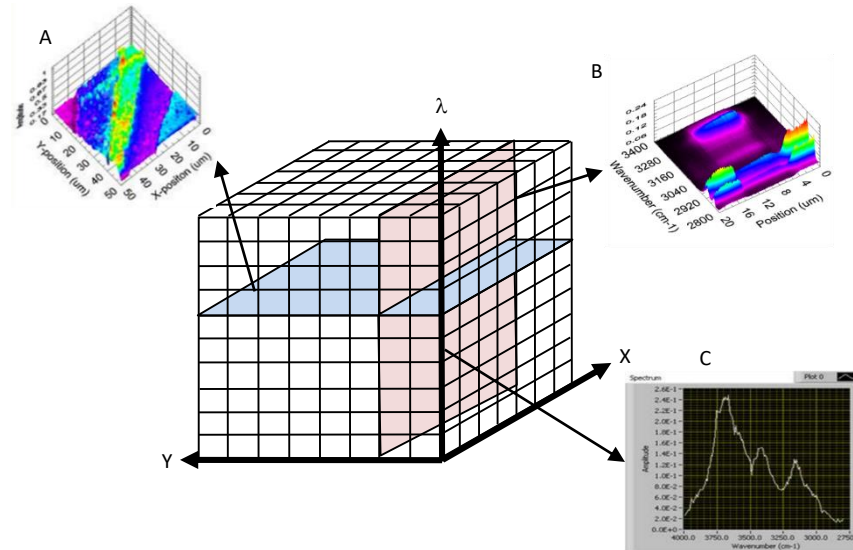
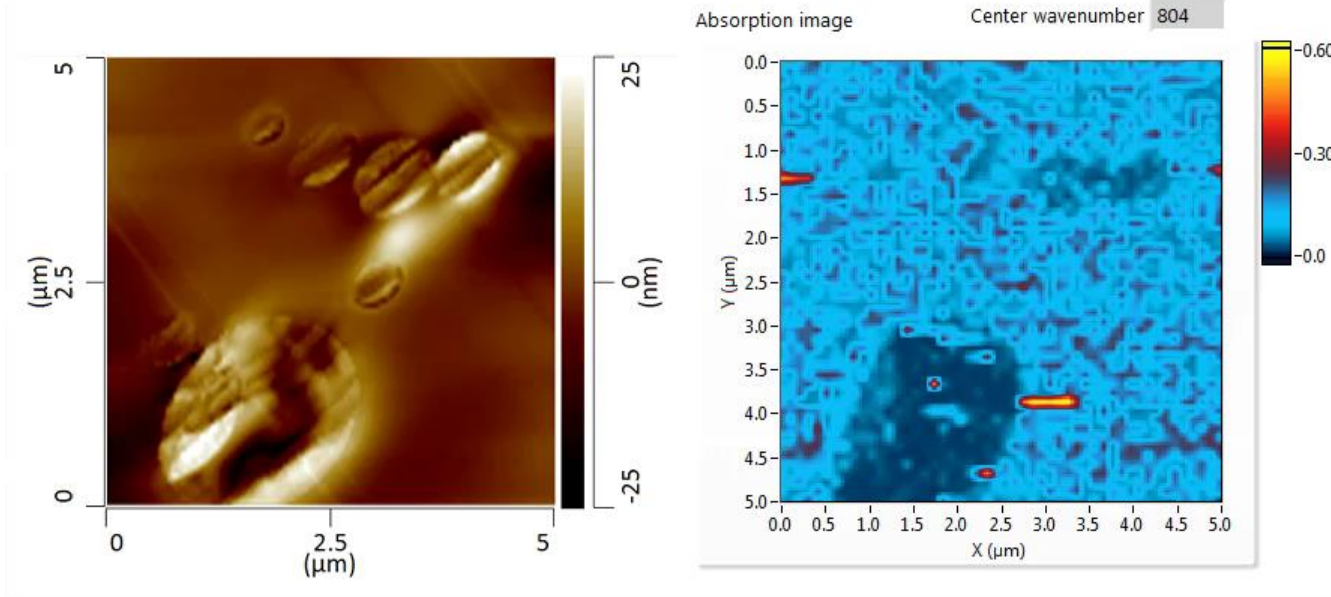

Figure 5. Illustration of the hyperspectral image cube. High speed AFM-based IR spectroscopy allow for the first time practical hyperspectral imaging, i.e., where spectra are mapped at matrix of XY points. One can extract segments of the hyperspectral cube to obtain (A) chemical maps that show spatial variation in absorption at a given wavelength, (B) spectral line maps showing the variation in spectra in one direction, or (C) individual spectra at any X,Y location.

Hyperspectral animation



5- μm x 5- μm , 50 x 50 spectrum array on PS/PMMA/epoxy blend



Move cursor onto above image and click on arrow to start animation

Hyperspectral array PCA weight maps



5- μm x 5- μm , 50 x 50 spectrum array on PS/PMMA/epoxy blend

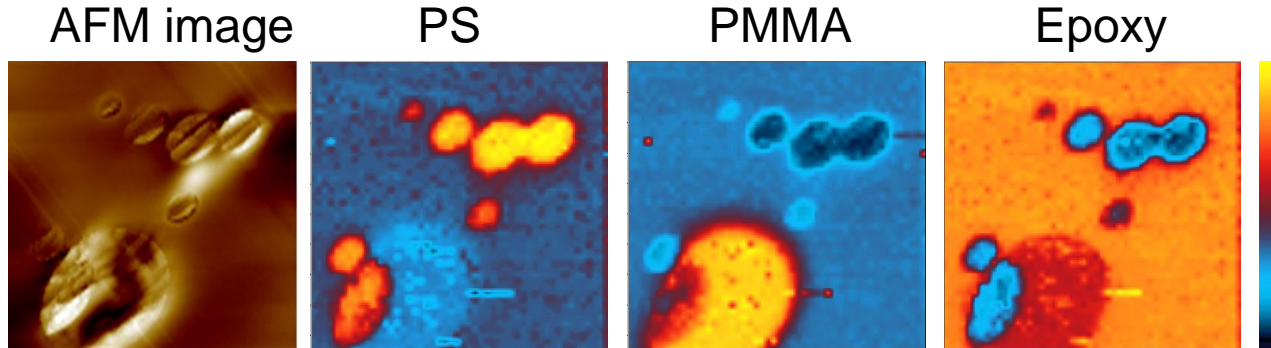

- New hyperspectral imaging provides point by point spectra over a large number of data points to provide an array of spectra and chemical images at specific wavenumbers
- Principle component analysis can be applied to identify specific chemical components and their spatial distribution

NEW nanoIR3 platform configurations



nanoIR3™ - Latest Generation nanoIR platform with Tapping AFM-IR

- Highest performance nanoIR spectra with AFM-IR
- Sub-10nm resolution IR chemical imaging with Tapping AFM-IR
- Correlates to FTIR & industry databases
- Easy to use for fast, productive measurements

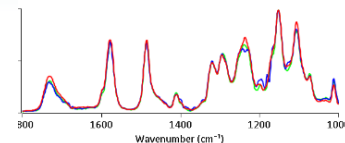

nanoIR Spectroscopy of Polyethersulphone (PES)

nanoIR3-s™ High Performance IR nano-spectroscopy

- Complementary s-SNOM & Tapping AFM-IR
- Highest Performance IR nano-spectroscopy
- Broadband Spectroscopy & Chemical Imaging
- Nanoscale property mapping
- *Versatility & Easy to Use*

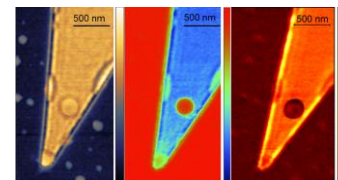

Plasmonic Imaging on Graphene with Tapping AFM-IR & s-SNOM

nanoIR3-s™ S-SNOM - High Performance s-SNOM Imaging

- IR s-SNOM platform for optical & chemical Imaging
- Supports multiple laser types, visible, nearIR
- Electrical nanoscale property mapping
- Upgradeable to nanoIR-spectroscopy

s-SNOM imaging
Phase and Amplitude
on HbN

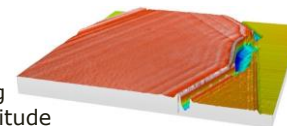

Sample Environmental Control

Humidity control & heater & cooler

- For control of humidity/gas & temperature for in-situ AFM-IR
- 4% to 95% non condensing
- 4°C to 80°C heating and cooling

	Available humidity control range	Maximum gas flow	Maximum X-Y motorized movement
	4 – 95%, non-condensing	250 ml/min	2mm x 2mm
Available temperature range		Available temperature range when paired with an environmental enclosure	
4 – 80 °C*		-20 – 80 °C	
<small>*Evaporation and condensation on the sample may impact results.</small>			

Sample transfer port for nanoIR3-s

- Protects sample in controlled gas environment from glove box to nanoIR system to protect
- includes integrated humidity sensor with optional high sensitivity humidity and oxygen sensors

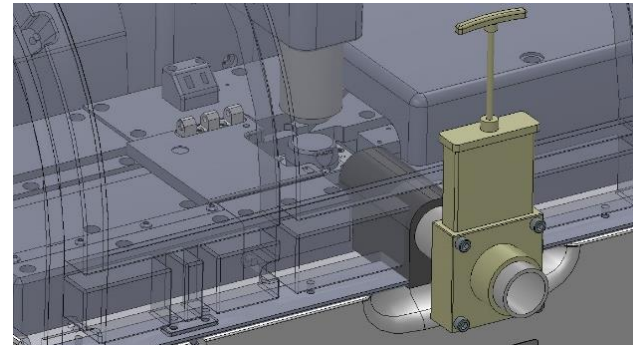

IR Polarization Control & extended IR range

Polarization control

Allows users to study molecular orientation with nanoscale spatial resolution by changing the input polarization of the IR light while studying the associated changes in the nanoscale IR spectra and/or chemical maps at a certain wavenumber.

Polarizer Option

Optional & upgradeable

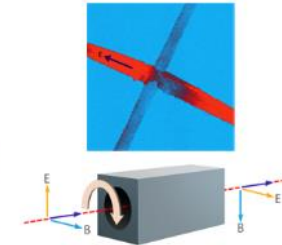
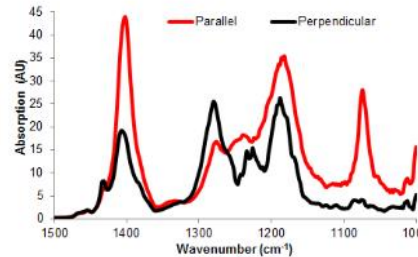

(L) AFM-IR spectra on electrospun PVDF fibers under two different IR polarizations (R) IR absorption image at 1404 cm^{-1} of crossed PVDF fibers under polarized illumination. (polarization direction shown by arrow)

New extended resonance enhanced AFM-IR range

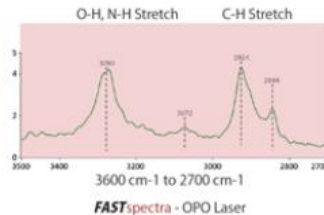

FASTspectra - OPO Laser

Previous resonance enhanced AFM-IR range

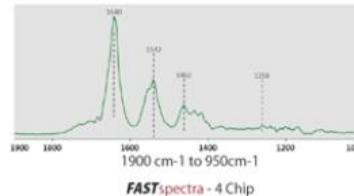

FASTspectra - 4 Chip

Nylon 12 nanoIR spectrum measured with both the new FASTspectra OPO and FASTspectra QCL lasers. Important C-H stretch, N-H stretch and OH regions are now enabled with rich interpretable data

FASTspectra™ OPO mid-IR laser

The new high pulse rate OPO laser extends the wavelength range of Resonance Enhanced AFM-IR to cover the 2700 to 3600 cm^{-1} wavenumbers, extending capability to important spectroscopic regions and addressing wider range of applications, while still providing direct correlation to FTIR at the nanoscale.

nanoIR nanoscale property mapping modes

Conducting AFM (CAFM):

(Application Module)

Allows the user to obtain simultaneous height and current flow maps of the sample surface. Available on all Anasys systems.

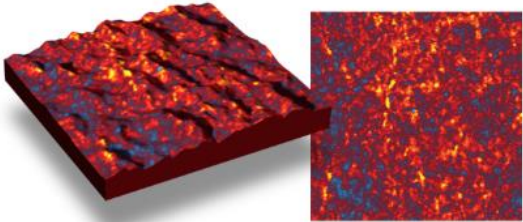

Height (Left) and Conductivity (Right) images of a nanocomposite polymer.

Kelvin Probe Force Microscopy (KPFM)

(Application Module)

Allows the user to obtain surface potential measurements. Available on all Anasys systems.

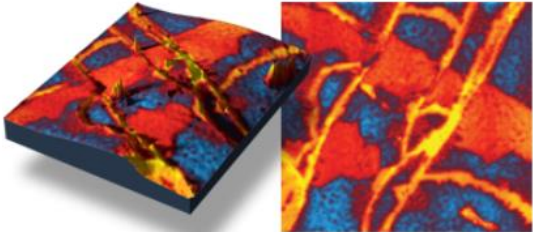

Height (Left) and Surface Potential (Right) images of a nanocomposite polymer.

Lorentz Contact Resonance mode

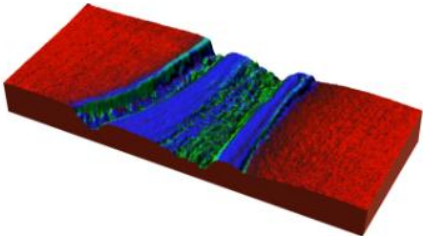

LCR composite image made by overlaying the LCR amplitudes collected at three different contact resonances. These resonances were selected to highlight the varying ratios of the lignin and cellulose which compose the sample.

Nano thermal analysis

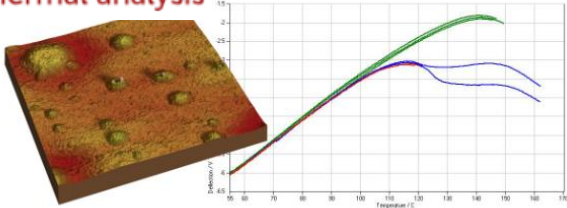

Nanoscale thermal analysis of a PS-PMMA blend deposited on glass. A scan (left) shows indents in the surface caused by temperature ramps (right). The data from the PS (red) and PMMA (green) clearly differentiate the two materials. Also shown is data from a thin film of PS on PMMA (blue) showing the initial penetration of the PS followed by the melting of the PMMA.

Tapping AFM-IR: Technical Overview

Concept

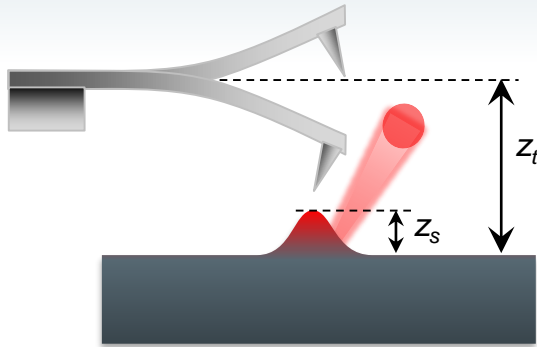

- Z_t : Distance of the Tip
- Z_s : Sample expansion (photothermal)
- k/γ : Linear/non-linear force constant
- a_s : Absorption coefficient
- a_t : Tip oscillation amplitude
- ω_p : Laser pulse rate
- ω_n : cantilever eigen mode frequency (n=1,2,3...)

$$F = k \cdot (z_t - z_s) + \gamma \cdot (z_t - z_s)^2$$

$$z_s = a_s(\lambda) \cos(\omega_p t)$$

$$z_t = a_t \cos(\omega_n t)$$



$$F \sim 2\gamma a_t a_s(\lambda) \cos(\omega_n t) \cos(\omega_p t)$$

$$F \sim \gamma a_t a_s(\lambda) [\cos(\omega_n + \omega_p)t + \cos(|\omega_n - \omega_p|)t]$$

Sum frequency

Diff. frequency

Fundamental mode Pulse rate 2nd Eigen mode

Resonance Condition: $\omega_1 + \omega_p = \omega_2$

Tapping AFM-IR: Technical Overview Schematic

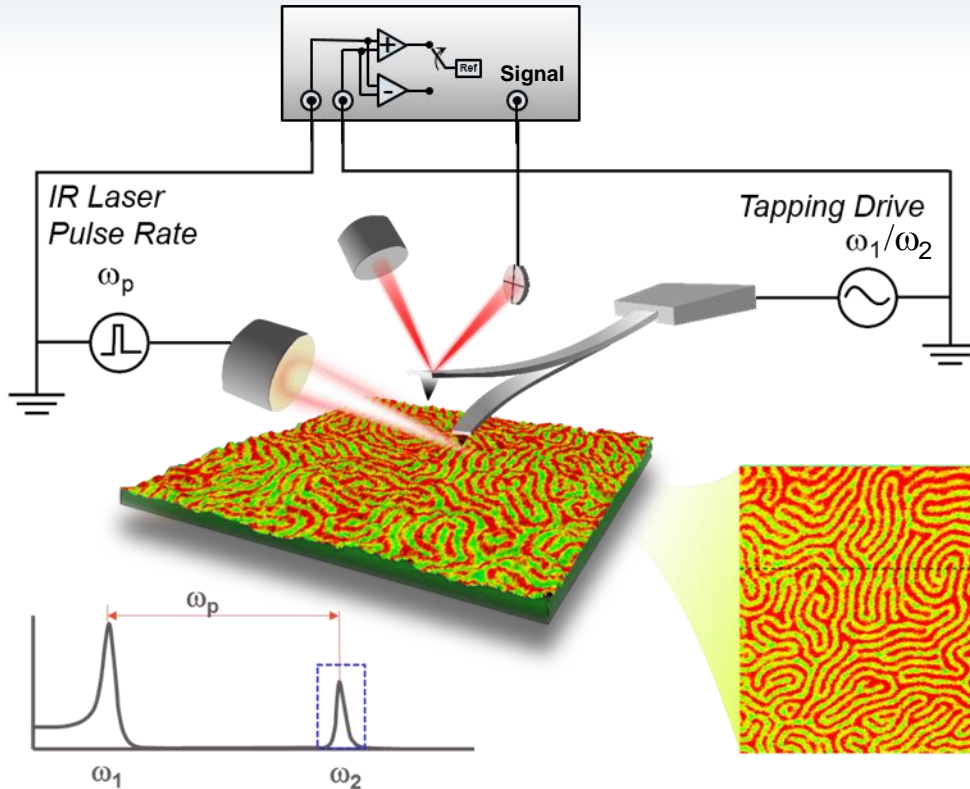

Heterodyne Force Microscopy

M.T. Cuberes, J. Nanomater., 2009

Resonance Condition:

$$\omega_1 + \omega_p = \omega_2$$

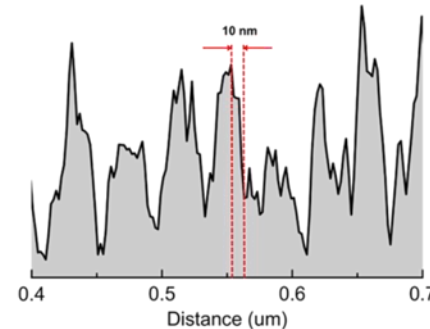

Tapping AFM-IR: Key features



- **Broad Application range:**
 - Hard/soft sample, Adhesives, Membranes, Particulates
 - Minimal sample/tip degradation due to absence of lateral forces
- **Improved Sensitivity:**
 - Sensitivity enhanced by cantilever Q-factor – new probes
 - AFM detector with higher sensitivity
 - Efficient optical beam delivery optics with minimal loss
- **High Spatial Resolution:**
 - Spatial resolution extends to ~ 10 nm or better
- **Multimodal Imaging:**
 - Simultaneous chemical and viscoelastic property (Tapping Phase) imaging

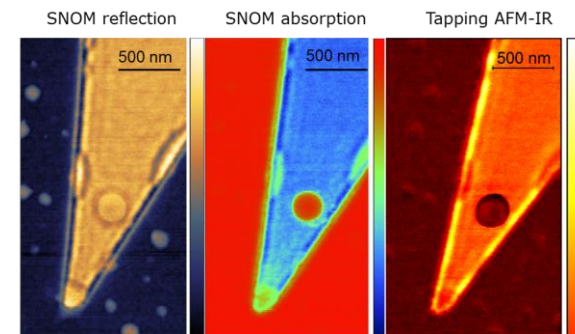
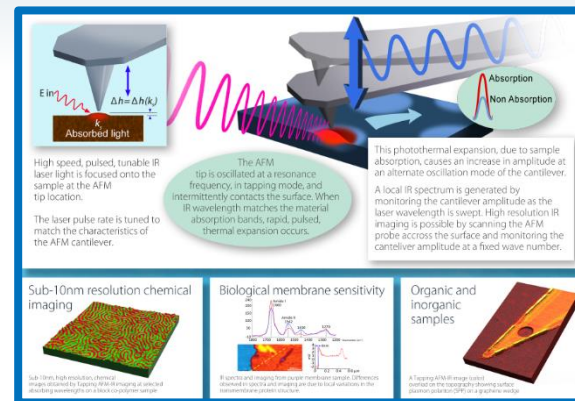

Measurement of graphene wedge on silicon with s-SNOM and Tapping AFM-IR show plasmonic effects at the edge

Tapping AFM-IR: Applications

Polymer 01: PEMA/PMMA Blend

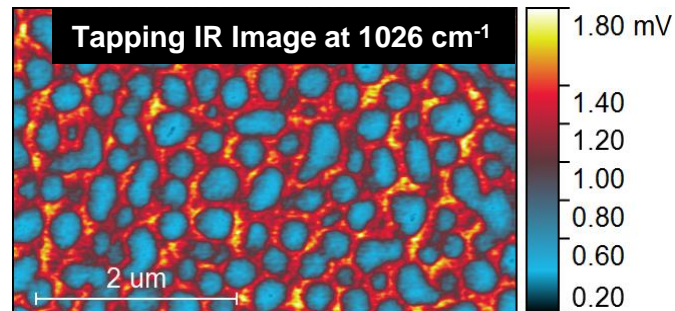
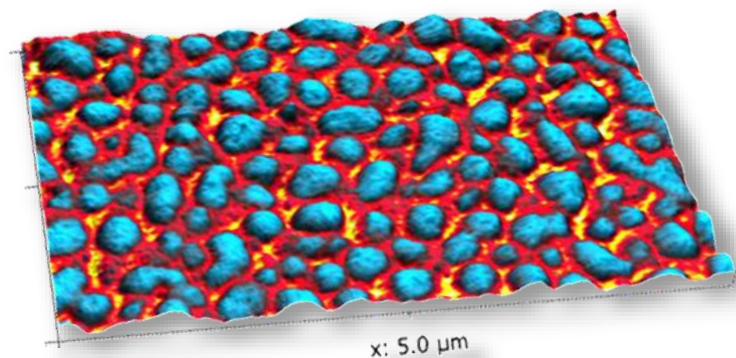
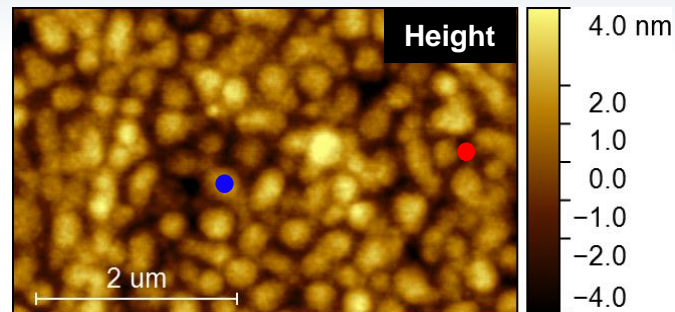
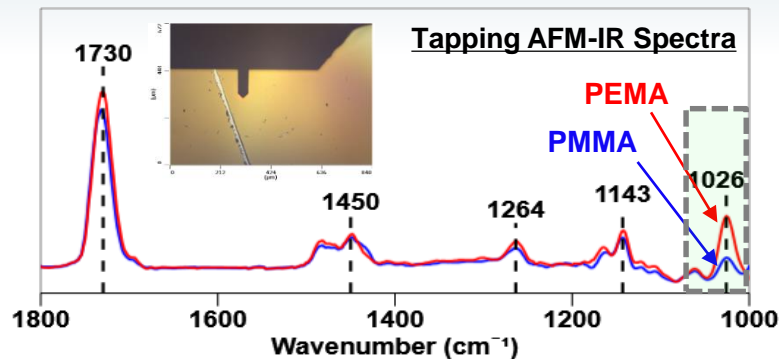

Sample courtesy: University of Minnesota

Tapping AFM-IR: Applications

Polymer 02: PS/PMMA block copolymer

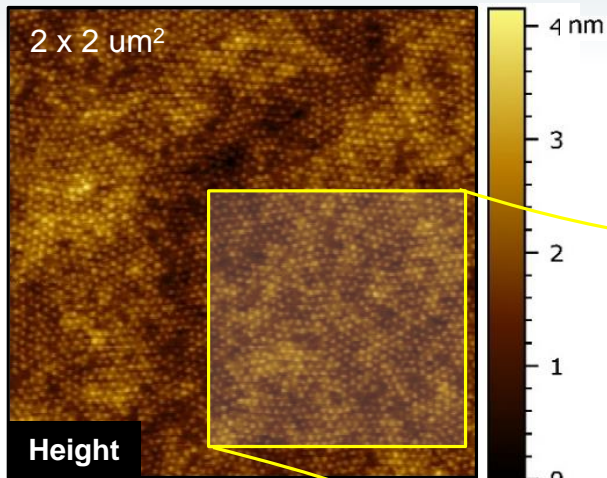

Tapping AFM-IR image at 1730 cm^{-1} highlights PMMA spheres embedded in PS matrix

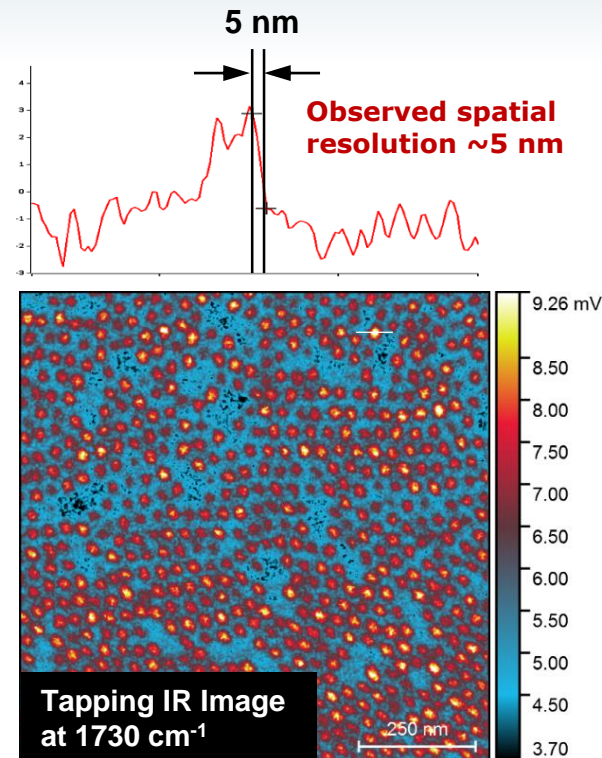
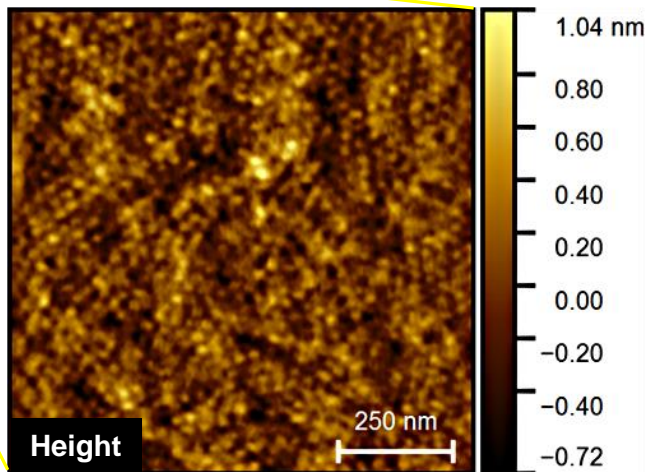

Sample courtesy: CEA-Leti

Tapping AFM-IR: Applications

Bio-pharmaceuticals 01: Skin/Dexamethasone

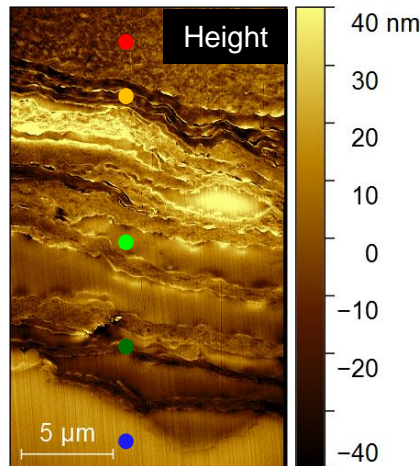
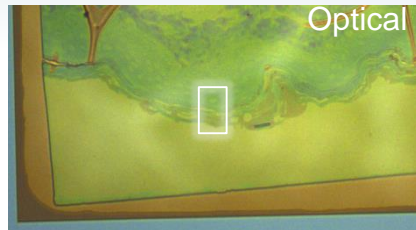

- Tapping AFM-IR image ratio at 1456/1740 cm^{-1} highlights the relative abundance of the drug in the lipophilic regions (bright yellow)

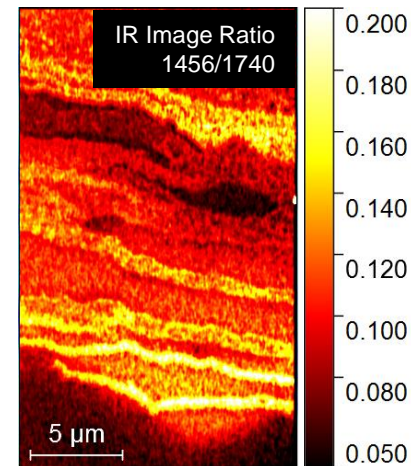
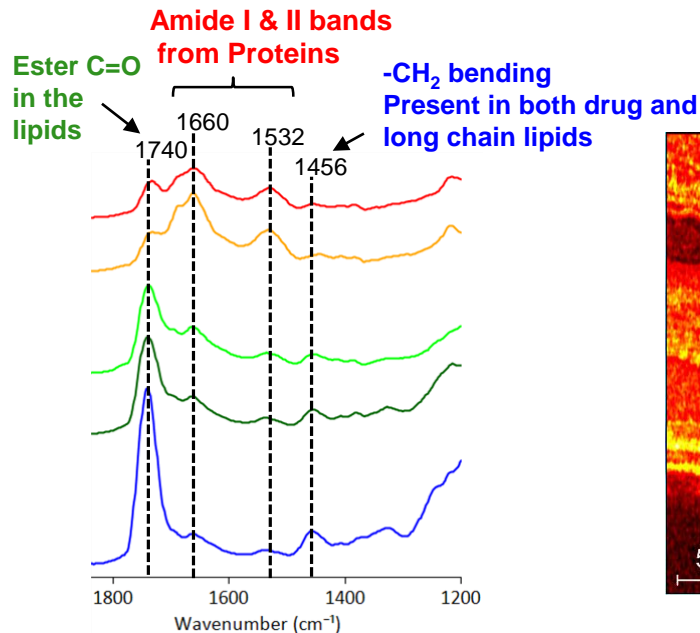

Sample courtesy: FU Berlin

Tapping AFM-IR: Applications

Bio-pharmaceuticals 02: Anti-cancer drug delivery

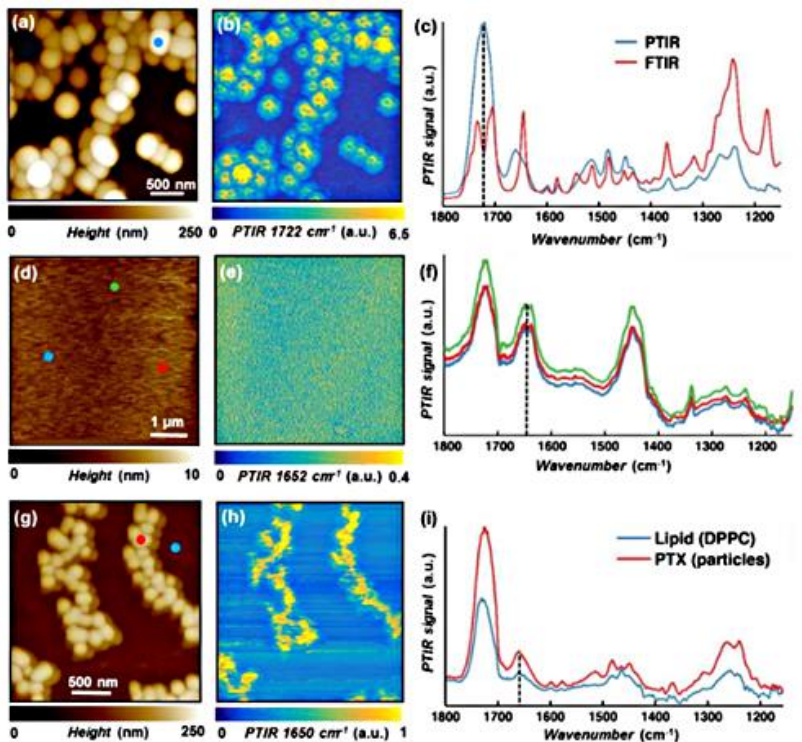

- Paclitaxel, a power anti-cancer drug, suffers from low efficacy and side effects due to low water solubility/recrystallization
- Recent study by Centrone and coworkers highlights the use of Tapping AFM-IR technology to explore the effect of different encapsulations in drug delivery
- High resolution compositional sensitivity of this technique unfolds new developments of lipid-polymer hybrid films in drug delivery applications

Centrone et al., *Analyst*, 2018, **143**, 3808-3813

Tapping AFM-IR: Applications

Organic Photovoltaics: TQ1/PC₇₀BM Blend

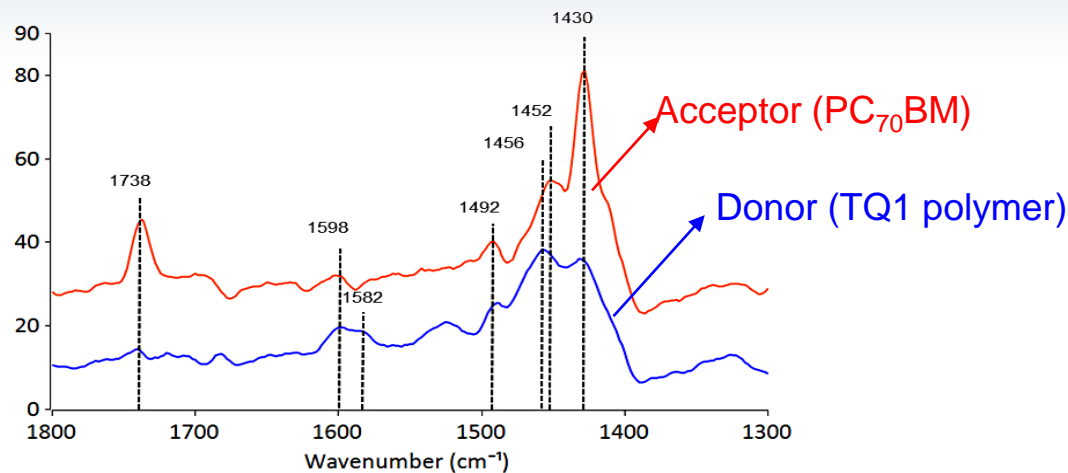
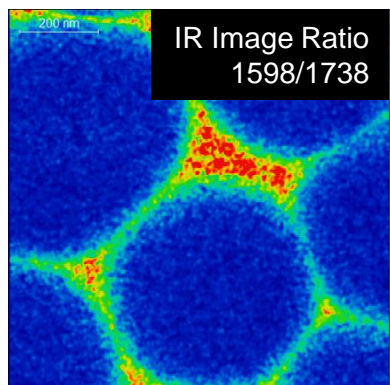
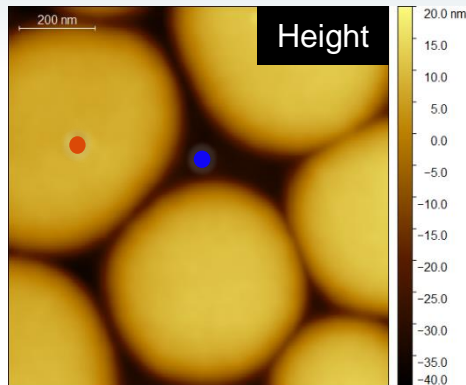

- Tapping AFM-IR spectra and images highlights the polymer rich matrix and PC₇₀BM rich domains

Sample courtesy: *Karlstad University*

Tapping AFM-IR: Applications

2D Materials: Graphene/Graphene Oxide



- Tapping AFM-IR spectra and images show sensitivity to monolayer Graphene and Graphene Oxide

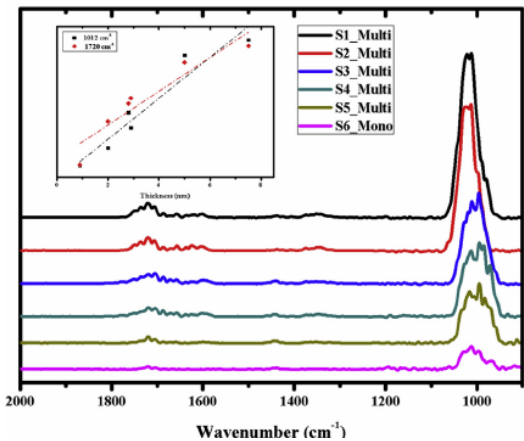
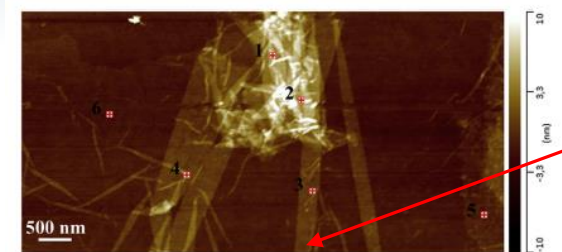

Liu et al., *Carbon*, 2018, 127, 141-148

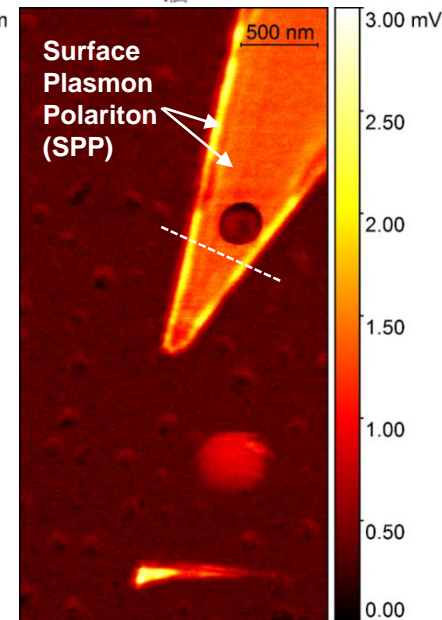
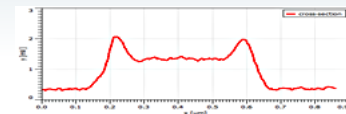
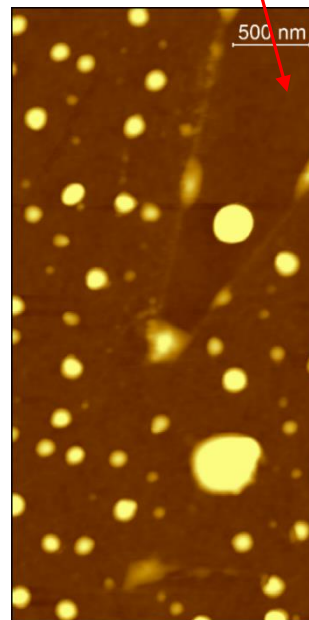

Manuscript in prep

Tapping AFM-IR: Applications

Failure Analysis: Organic Nanocontaminations

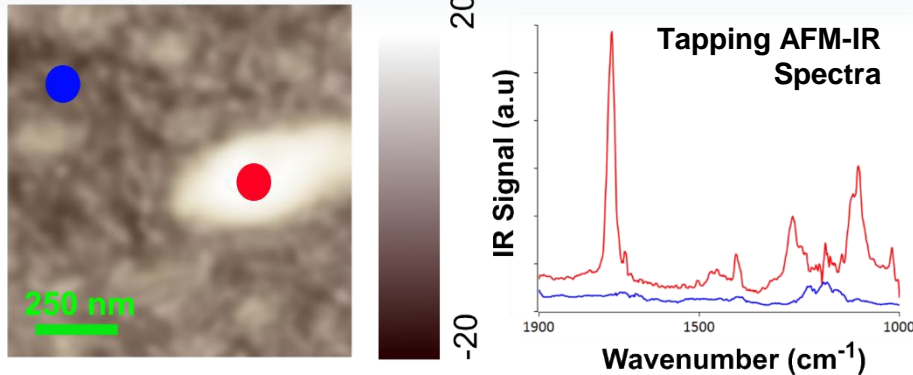

FTIR Library Search

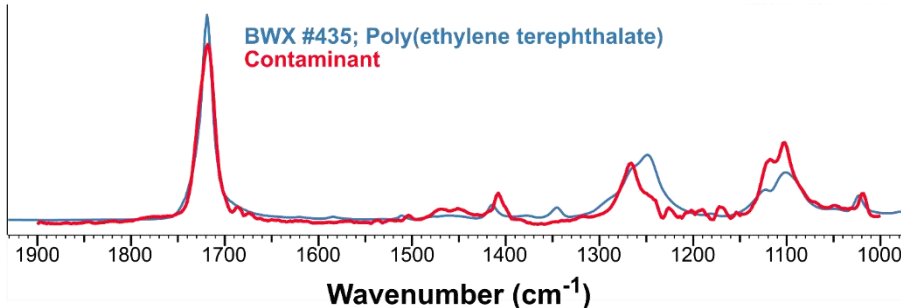

“...Knowing why devices fail is a must when designing next-generation products..”

V. Lakshminarayanan
www.rfdesign.com, 2011

- AFM-IR technology complements traditional analytical tools used for failure analysis in nanoscale semiconductor devices/architectures
- Enhanced sensitivity extends to samples with thickness <20 nm
- Tapping AFM-IR technology demonstrates positive identification of nanoscale organic contaminants on Silicon wafer

Tapping AFM-IR Measurements on nanocontaminant sample

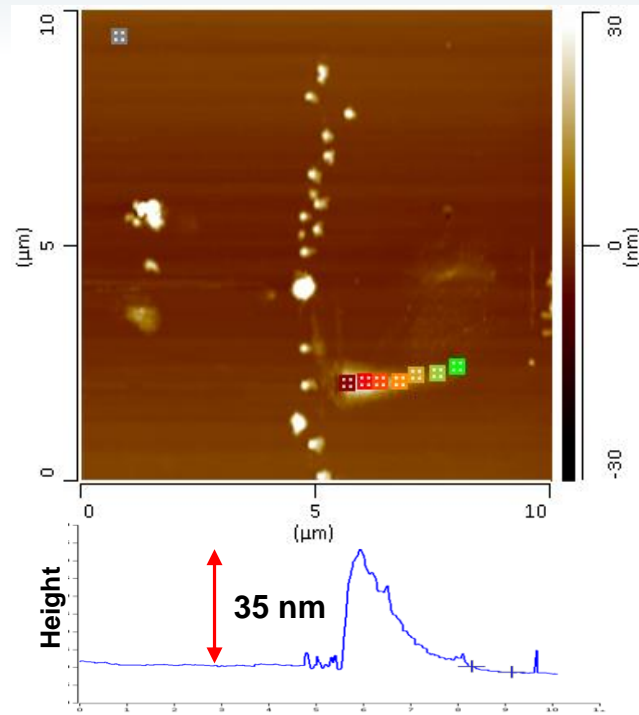
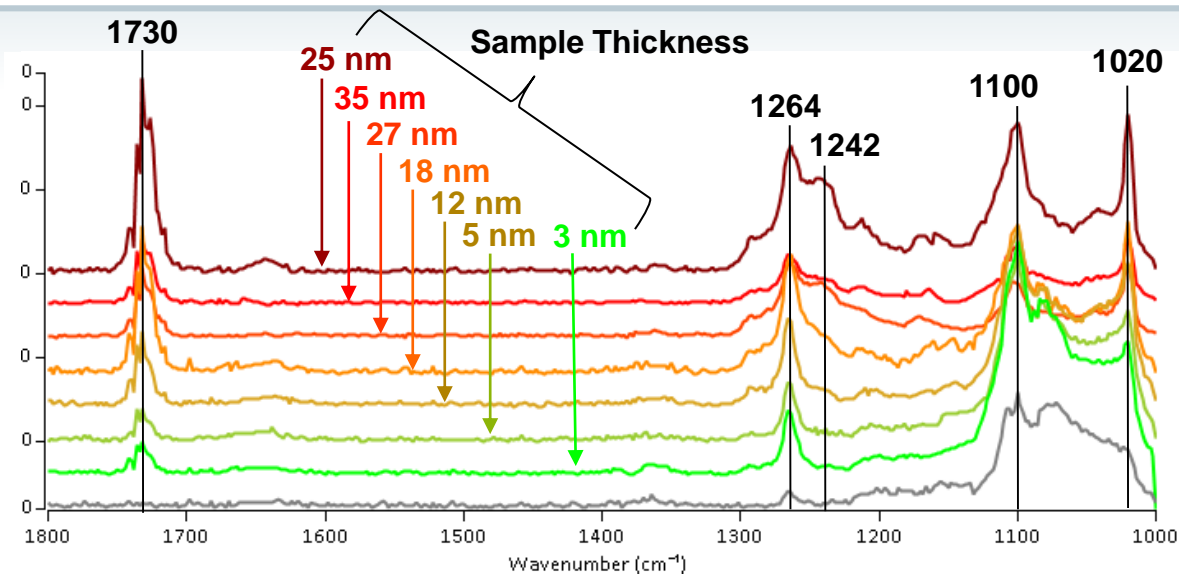

- Each spectrum is an average of 5 measurements, **NOT** smoothed
- Tapping AFM-IR spectra show absorption bands consistent with earlier measurements performed onsite – contamination is most likely synthetic polyester (PET/PBT)
- IR signal **sensitivity goes down to 3 nm thick residue** (bright green)

Tapping AFM-IR of a Biological Membrane

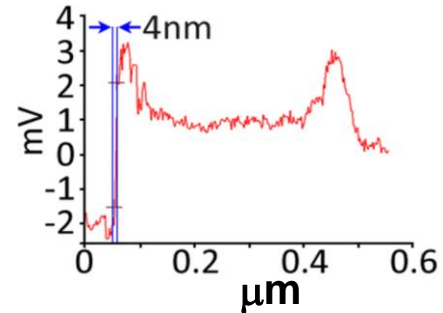
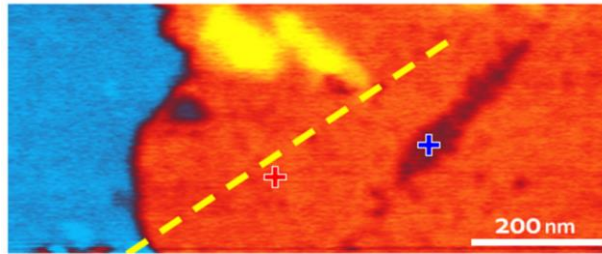
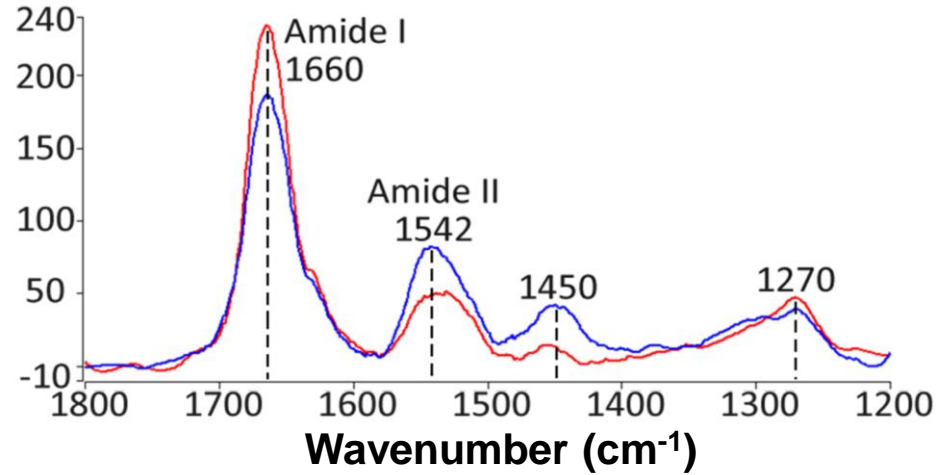

Polymeric Nanoparticles for drug delivery

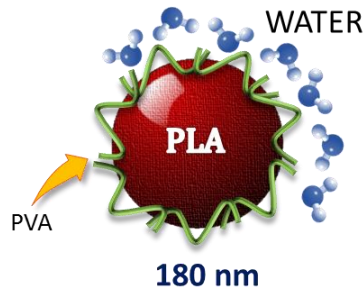

FTIR spectra of products

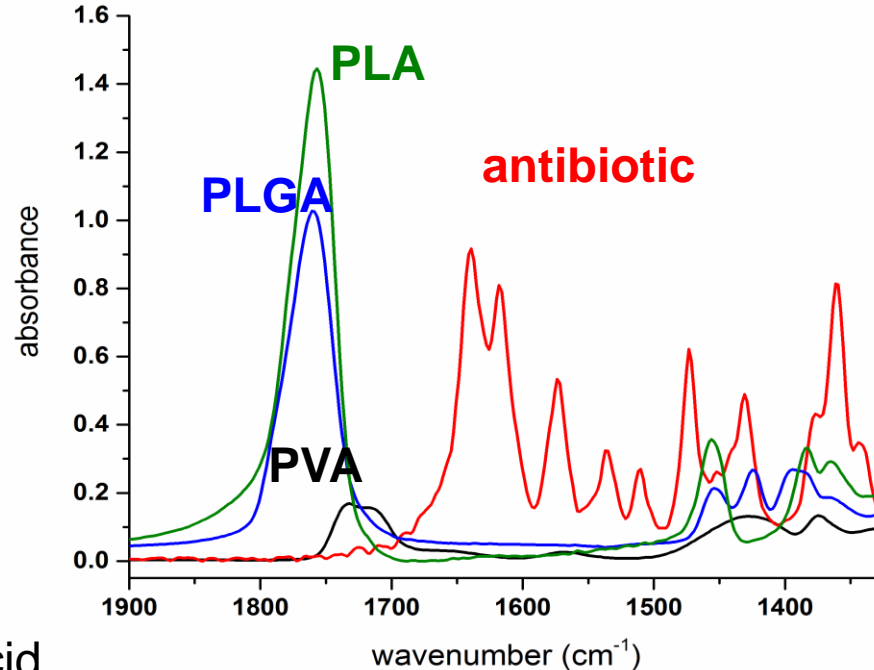

Antibiotic = pipemidic acid

Polymeric Nanoparticles for drug delivery



PLA/PVA nanoparticle

Mapping at 1760 cm^{-1} center on ester carbonyl band of PLA

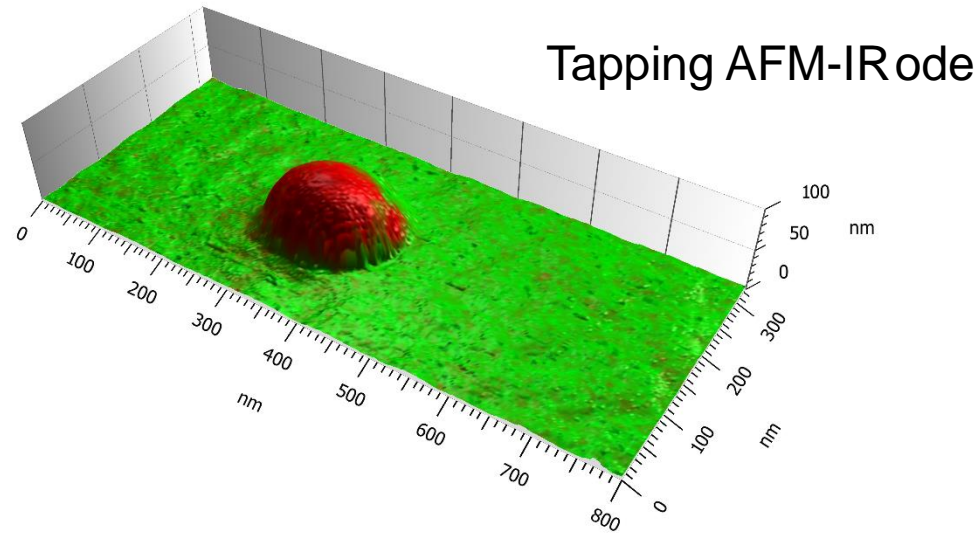

Polymeric Nanoparticles for drug delivery



PLA/PVA nanoparticle

Mapping at 1425 cm^{-1} center on absorption band of PVA

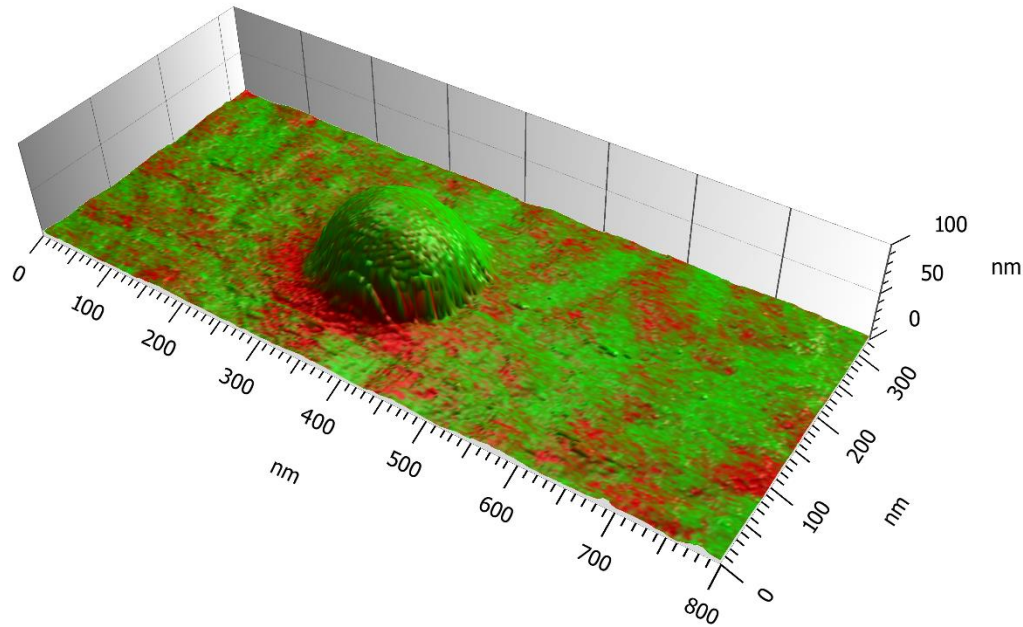

PLGA/PVA nanoparticles with antibiotic

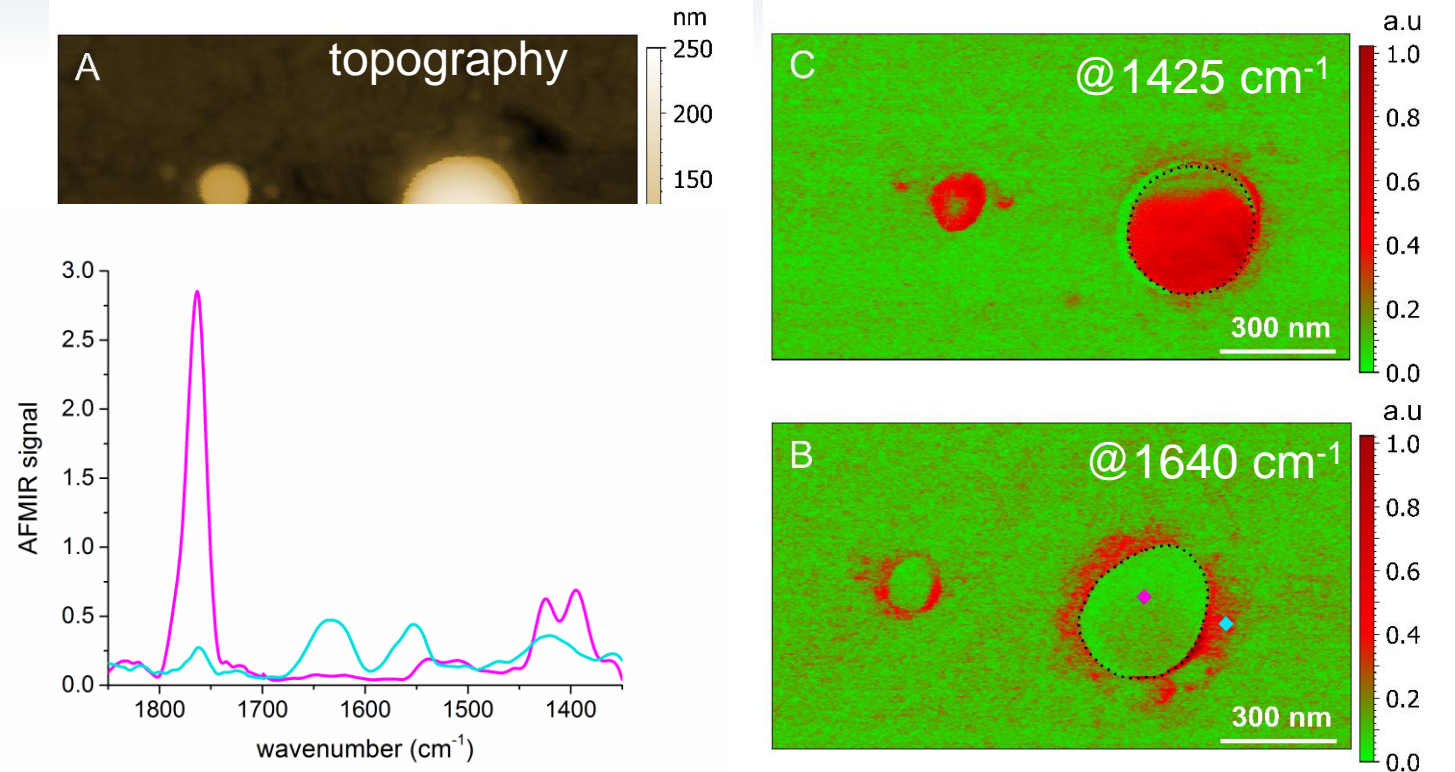

Benefits of Tapping AFM-IR approach



- **Better spatial resolution/softer samples via tapping AFM**
- **Improved chemical imaging via heterodyne detection**
 - **Insensitive to non-local background forces**
- **Material selectivity via resonance tuning**

Complementary: AFM-IR and s-SNOM scattering scanning nearfield optical microscopy

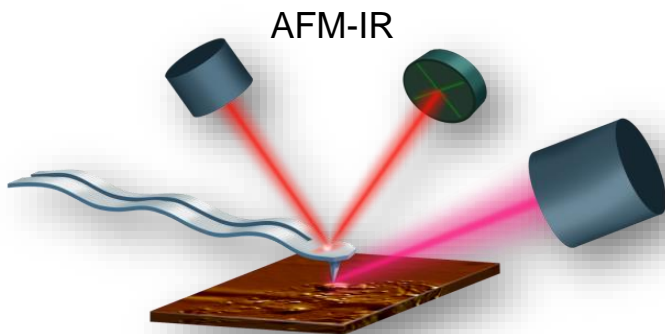

Thermal expansion proportional to absorption and thermal expansion coefficients

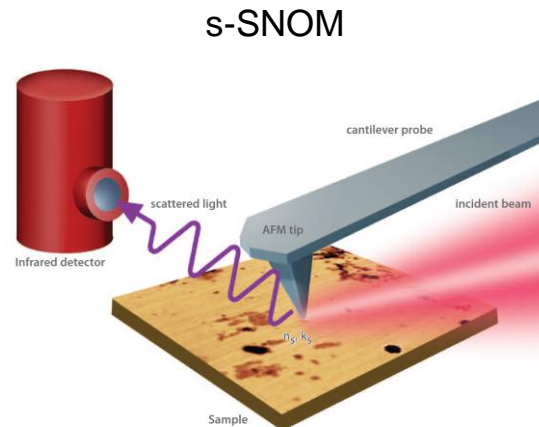

Scattered light depends on complex optical constants

Sensitivity of AFM-IR and s-SNOM

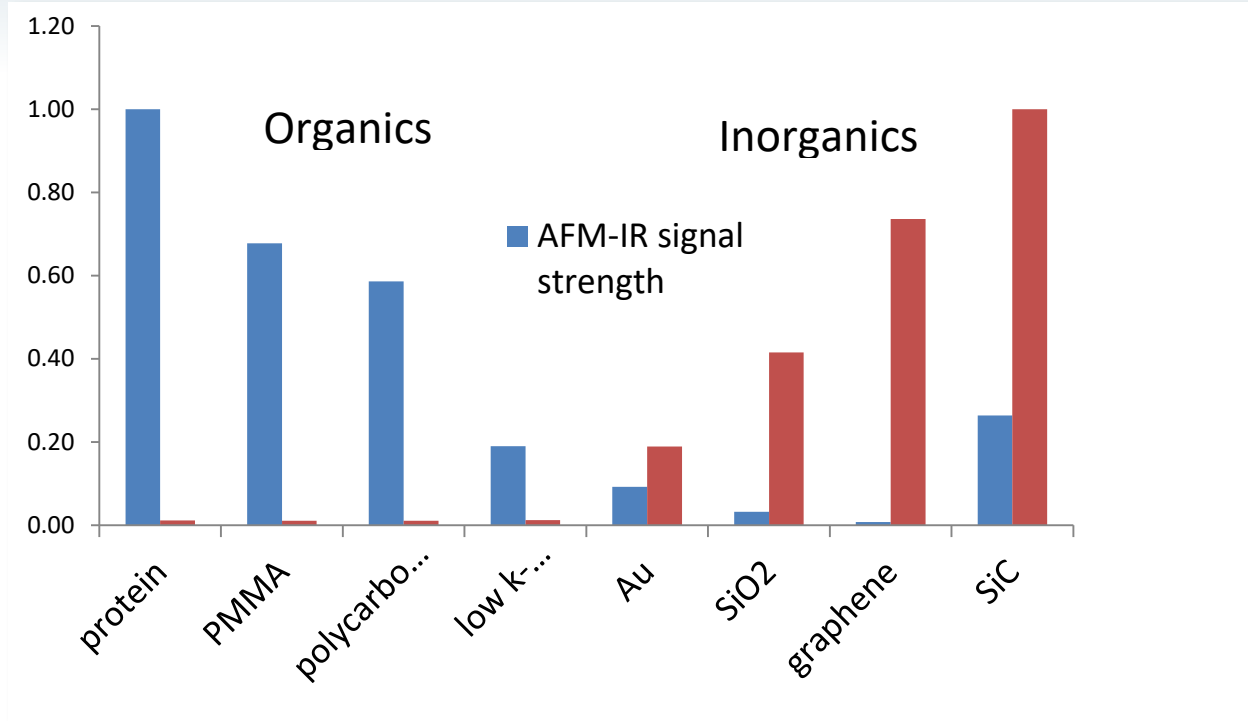

s-SNOM: complex optical property



Metal coated tip acts like an antenna to enhance and localize the light.

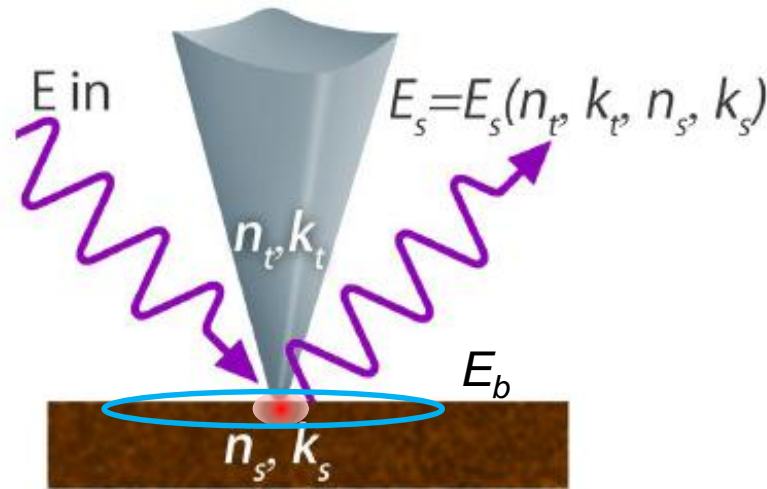

Spatial resolution: tip radius 10~20 nm

Previous: Spatio-spectral Imaging & Broadband Spectroscopy



Spatio-spectral Imaging

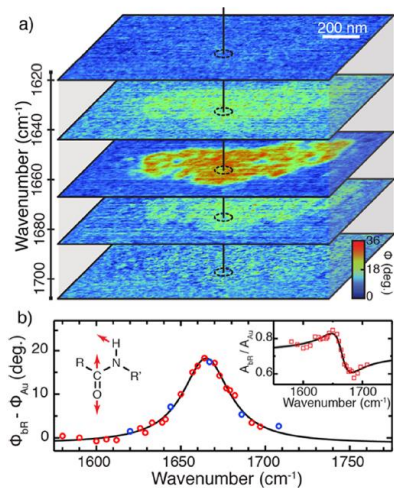

J. Am. Chem. Soc., 2013, 135, 18292

Disadvantages: slow, limited spectral resolution

Broadband Spectroscopy

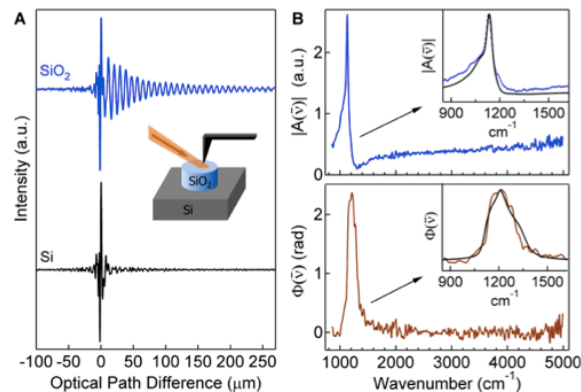

Proc. Natl. Acad. Sci. 111, 7191 (2014)

Disadvantages: can't do narrowband imaging (e.g. for compositional mapping)

Application: Fano-resonance Bilayer Graphene

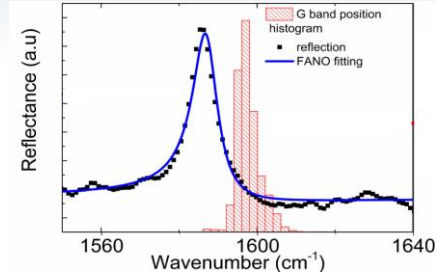
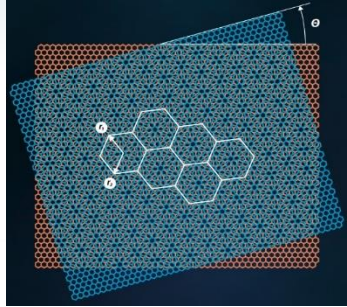

Graphene 2, 38727 (2013)

AFM height

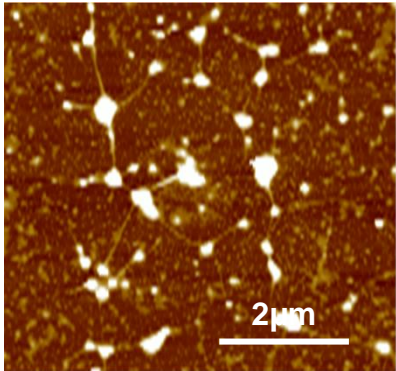

sSNOM 1580 cm^{-1}

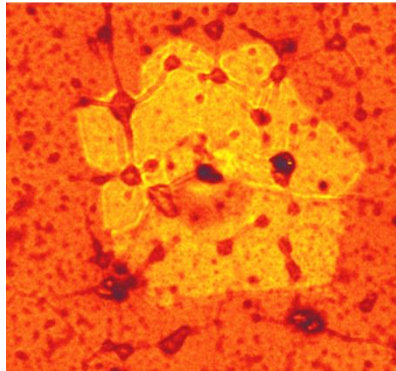

sSNOM 1600 cm^{-1}

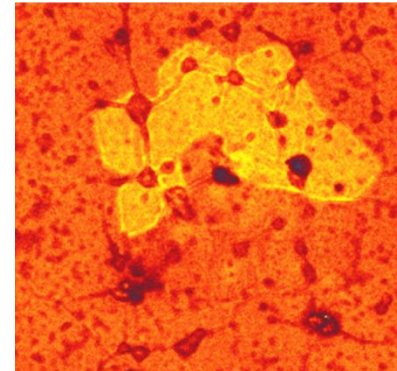

s-SNOM with a broadband laser source

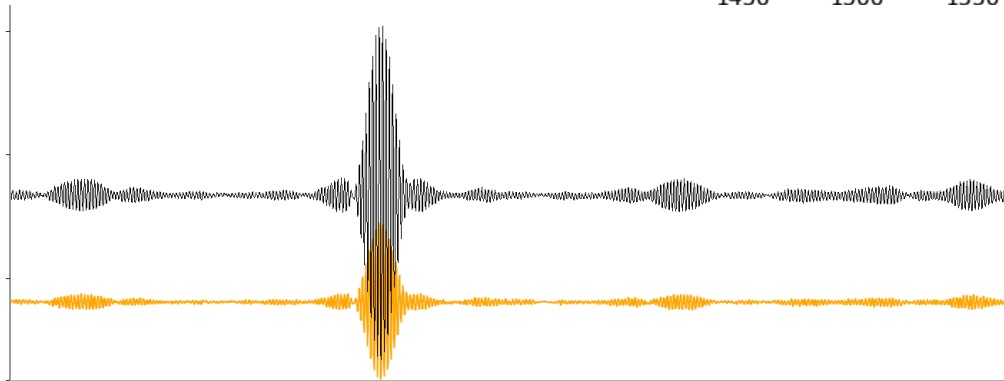
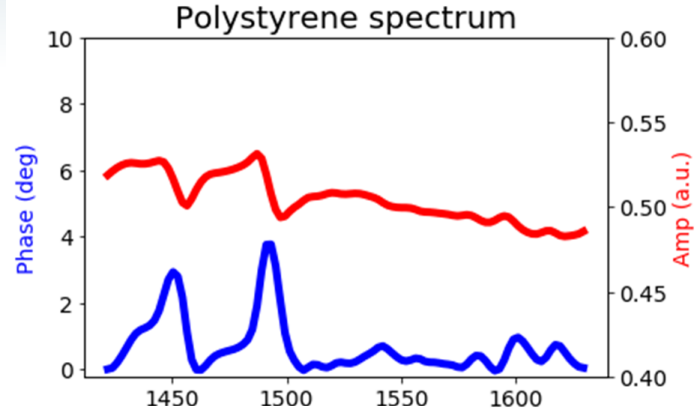
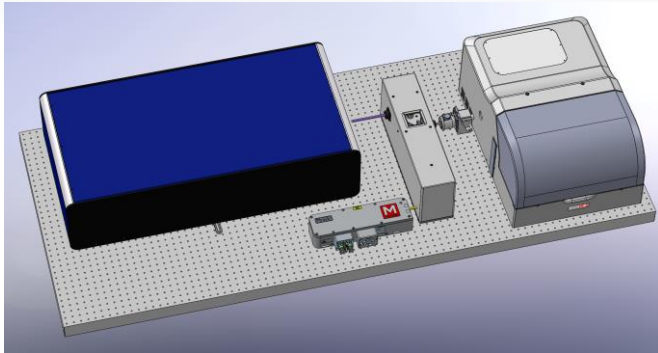

s-SNOM spectrum of polystyrene below 800 cm^{-1}

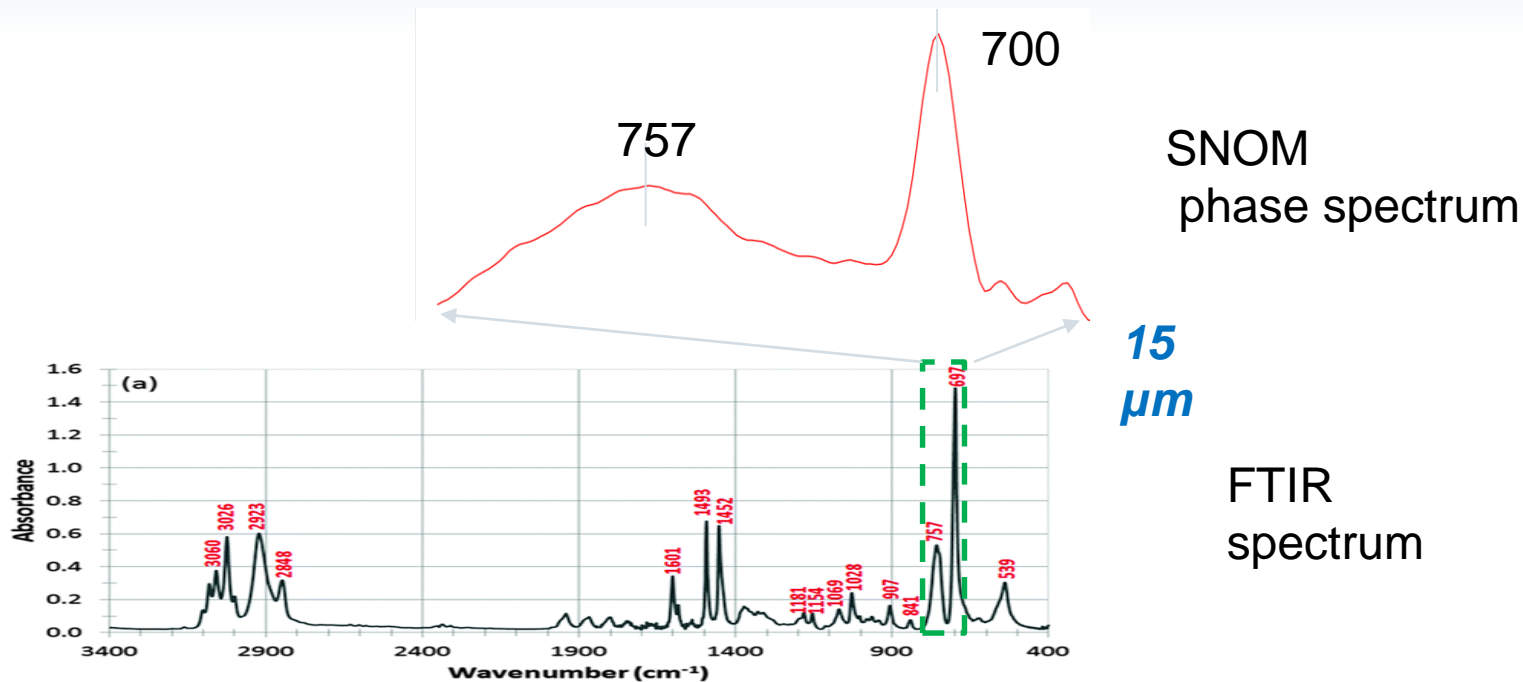

nanolR Laser Options

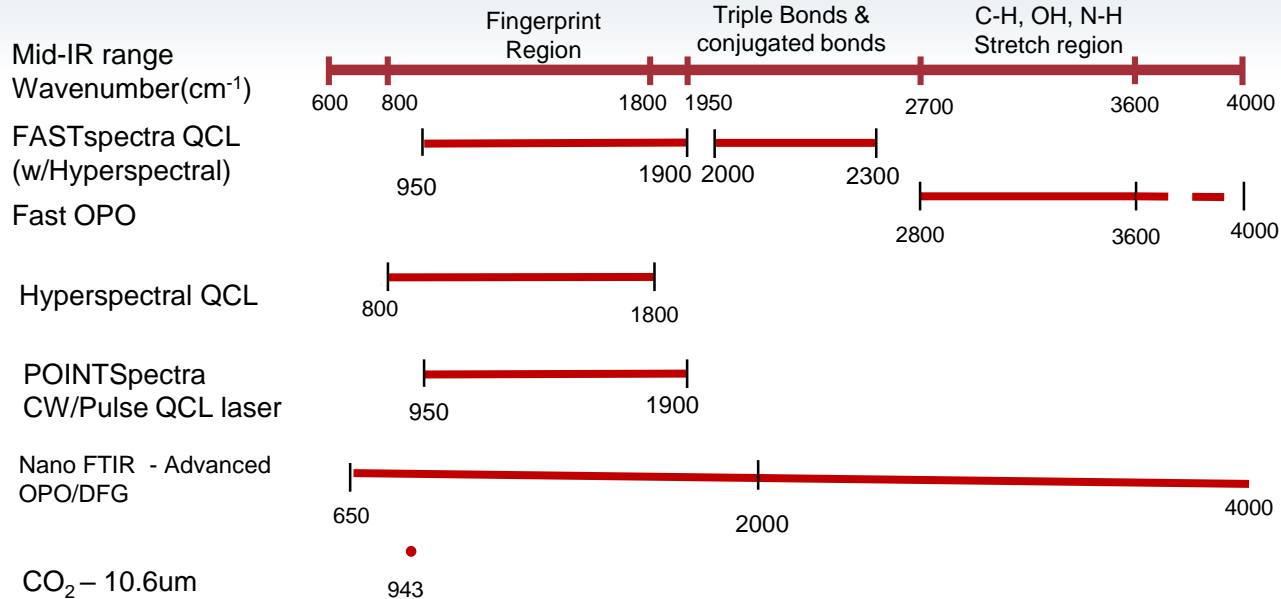

- AFM-IR lasers (Pulsed tunable OPO & QCL) can provide both spectroscopy & wavelength specific imaging
- Only CW/P QCL (tunable) lasers provide spectroscopy & wavelength specific imaging for s-SNOM
- nanoFTIR lasers only provide spectroscopy & imaging capabilities (AFM-IR&s-SNOM)

Additional Applications – from 2017-2018 publications



- Life Science
 - Recent paper in Cell – Simone Ruggeri, Tuomas Knowles (Cambridge)
 - AFM-IR in Fluid – Andrea Centrone (NIST)
 - Malaria Infected Red Blood Cells – Bayden Wood (Monash)
 - *In vivo* AFM-IR of Bacteria – Bayden Wood (Monash)
- Materials Science
 - Deuterium-labeled polyolefin copolymer blend - Dow
 - Core/Shell effect in electrospun PHB copolymer fibers – Delaware
 - Functionalized graphene - Manchester
 - h-BN – Photothermal AFM-IR of 2D Materials - Harvard
 - Geoscience - Schlumberger & USGS

Additional Applications (continued)



- Atmospheric Aerosols – Mark Banaszak Holl (Michigan/Monash)
- Polarized AFM-IR – Karsten Hinrichs (ISAS)

Recent Technological Advancements in nanoscale IR Technology offers

- Unmatched sensitivity for nanoIR spectroscopy & chemical imaging
- <10nm resolution chemical imaging
- Point spectroscopy in 1-2 secs
- HYPERspectral imaging/Spectroscopy for robust statistical analysis
- Easy to use, high performance AFM imaging with improved noise and sensitivity

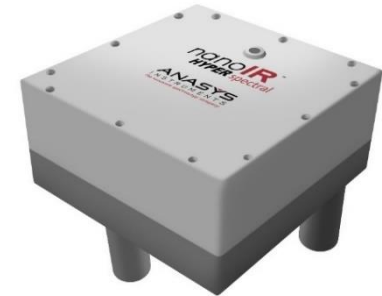

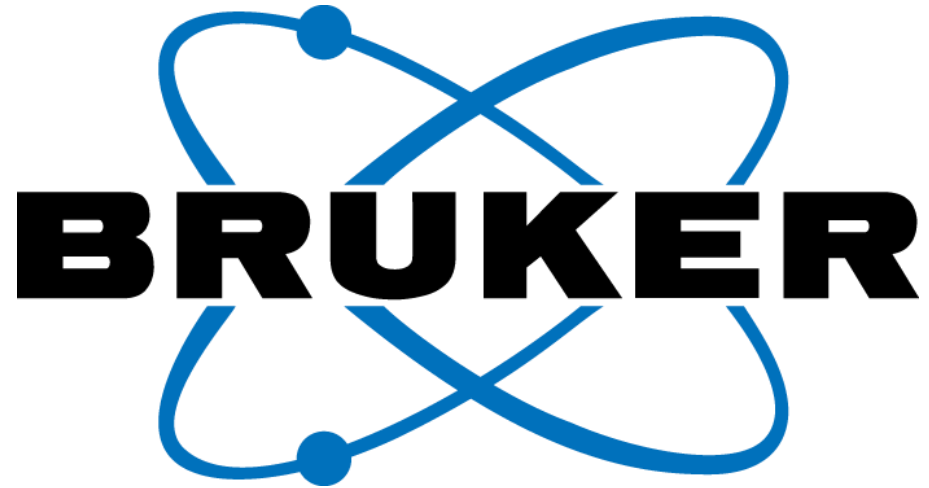

www.bruker.com